

DAIKIN ROOM AIR CONDITIONER

OPERATION MANUAL

INVERTER

English

Français

Español



MODELS

- FTXS09LVJU
- FTXS12LVJU
- CTXS07LVJU

Feature

For your comfort and energy saving



INTELLIGENT EYE

The INTELLIGENT EYE sensor detects the human movement in a room. If no one is room for more than 20 minutes, the operation automatically changes to energy saving operation.

▶Page 15



WEEKLY TIMER

Up to 4 timer settings can be saved for each day of the week according to your family's life style. The WEEKLY TIMER allows you to set on/off time and the desired temperature. ▶Page 22

Other functions



COMFORT AIRFLOW

The airflow direction will be in upward mode while in COOL operation, in downward mode while in HEAT operation. This function will prevent cold or warm air from directly blowing on your body. ▶Page 15



OUTDOOR UNIT QUIET

OUTDOOR UNIT QUIET operation lowers the noise level of the outdoor unit. This function is useful in consideration of your neighbors.









▶Page 18

Contents

■ Read before Operation

Safety Considerations	3
Names of Parts	5
Preparation before Operation	9

■ Operation

 AUTO · DRY · COOL · HEAT · FAN Operation	11
 Adjusting the Airflow Direction and Rate	13
 COMFORT AIRFLOW / INTELLIGENT EYE Operation.....	15
 POWERFUL Operation.....	17
 OUTDOOR UNIT QUIET Operation	18
 ECONO Operation	19
 OFF 0:00 OFF TIMER Operation.....	20
 ON 6:00 ON TIMER Operation.....	21
 WEEKLY WEEKLY TIMER Operation.....	22

■ Multi Connection

Note for Multi System	28
-----------------------------	----

■ Care

Care and Cleaning	30
-------------------------	----

■ Troubleshooting

Troubleshooting	35
-----------------------	----



ECONO

This function enables efficient operation by limiting the maximum power consumption. It is useful when using the air conditioner and other electrical devices simultaneously. ▶Page 19

Safety Considerations

Read these **Safety Considerations for Operations** carefully before operating an air conditioner or heat pump.

Make sure that the unit operates properly during the startup operation. Instruct the user on how to operate and maintain the unit.

Inform users that they should store this operation manual with the installation manual for future reference.

Meanings of **DANGER**, **WARNING**, **CAUTION**, and **NOTE** Symbols:

 **DANGER** Indicates an imminently hazardous situation which, if not avoided, will result in death or serious injury.

 **WARNING** Indicates a potentially hazardous situation which, if not avoided, could result in death or serious injury.

 **CAUTION** Indicates a potentially hazardous situation which, if not avoided, may result in minor or moderate injury. It may also be used to alert against unsafe practices.

 **NOTE** Indicates situations that may result in equipment or property-damage accidents only.

DANGER

- Do not install the unit in an area where flammable materials are present due to risk of explosion resulting in serious injury or death.
- Any abnormalities in the operation of the air conditioner or heat pump, such as smoke or fire, could result in severe injury or death. Turn off the power and contact your dealer immediately.
- Refrigerant gas may produce toxic gas if it comes into contact with fire, such as from a fan heater, stove, or cooking device. Exposure to this gas could cause severe injury or death.
- For refrigerant leakage, consult your dealer. Refrigerant gas is heavier than air and replaces oxygen. A massive leak could lead to oxygen depletion, especially in basements, and an asphyxiation hazard could occur leading to serious injury or death.
- If equipment utilizing a burner is used in the same room as the air conditioner or heat pump, there is the danger of oxygen deficiency which could lead to an asphyxiation hazard resulting in serious injury or death. Be sure to ventilate the room sufficiently to avoid this hazard.
- Safely dispose of the packing materials. Packing materials, such as nails and other metal or wooden parts, may cause stabs or other injuries.
- Tear apart and throw away plastic packaging bags so that children will not play with them. Children playing with plastic bags face the danger of death by suffocation.

WARNING

- Contact your dealer for repair and maintenance. Improper repair and maintenance may result in water leakage, electric shock, and fire. Only use accessories made by Daikin that are specifically designed for use with the equipment and have them installed by a professional.
- Contact your dealer to move and reinstall the air conditioner or heat pump. Incomplete installation may result in water leakage, electric shock, and fire.
- Never let the indoor unit or the remote controller get wet. Water can cause an electric shock or a fire.
- Never use flammable spray such as hair spray, lacquer, or paint near the unit. Flammable spray may cause a fire.
- When a fuse blows out, never replace it with one of incorrect ampere ratings or different wires. Always replace any blown fuse with a fuse of the same specification.
- Never remove the fan guard of the unit. A fan rotating at high speed without the fan guard is very dangerous.
- Never inspect or service the unit by yourself. Contact a qualified service person to perform this work.
- Turn off all electrical power before doing any maintenance to avoid the risk of serious electric shock; never sprinkle or spill water or liquids on the unit.
- Do not touch the switch with wet fingers. Touching a switch with wet fingers can cause electric shock.
- Do not allow children to play on or around the unit to prevent injury.
- The heat exchanger fins are sharp enough to cut. To avoid injury wear gloves or cover the fins while working around them.
- Do not put a finger or other objects into the air inlet or air outlet. The fan is rotating at high speed and will cause injury.
- Check the unit foundation for damage on a continuous basis, especially if it has been in use for a long time. If left in a damaged condition the unit may fall and cause injury.
- Placing a flower vase or other containers with water or other liquids on the unit could cause a shock or fire if a spill occurs.
- Do not touch the air outlet or horizontal blades while the swing flap is in operation because fingers could get caught and injured.
- Never touch the internal parts of the controller. Do not remove the front panel because some parts inside are dangerous to touch. To check and adjust internal parts, contact your dealer.

CAUTION

- Do not use the air conditioner or heat pump for any other purposes other than comfort cooling or heating. Do not use the unit for cooling precision instruments, food, plants, animals or works of art.

- Do not place items under the indoor unit as they may be damaged by condensates that may form if the humidity is above 80% or if the drain outlet gets blocked.
- Before cleaning, stop the operation of the unit by turning the power off or by pulling the supply cord out from its receptacle. Otherwise, an electric shock and injury may result.
- Do not wash the air conditioner or heat pump with excessive water. An electric shock or fire may result.
- Avoid placing the controller in a spot splashed with water. Water entering the controller may cause an electric shock or damage the internal electronic parts.
- Do not operate the air conditioner or heat pump when using a room-fumigation type of insecticide. Failure to observe this could cause the chemicals to be deposited in the unit and can endanger the health of those who are hypersensitive to chemicals.
- Do not turn off the power immediately after stopping operation. Always wait for at least 5 minutes before turning off the power. Otherwise, water leakage may occur.
- The appliance is not intended for use by young children or infirm persons without supervision.
- The remote controller should be kept away from children so they cannot play with it.
- Consult with the installation contractor for cleaning.
- Incorrect cleaning of the inside of the air conditioner or heat pump could make the plastics parts break and cause water leakage or electric shock.
- Do not touch the air inlet or aluminum fin of the air conditioner or heat pump as they can cut and cause injury.
- Do not place objects in direct proximity of the outdoor unit. Do not let leaves and other debris accumulate around the unit. Leaves are a hotbed for small animals which can enter the unit. Once inside the unit, animals can cause the unit to malfunction, and cause smoke or fire when they make contact with electrical parts.
- Dismantling of the unit, disposal of the refrigerant, oil, and additional parts, should be done in accordance with the relevant local, state, and national regulations.
- Operate the air conditioner or heat pump in a sufficiently ventilated area and not surrounded by obstacles. Do not use the air conditioner or heat pump in the following places.
 - a. Places with a mist of mineral oil, such as cutting oil.
 - b. Locations such as coastal areas where there is a lot of salt in the air.
 - c. Locations such as hot springs where there is a lot of sulfur in the air.
 - d. Locations such as factories where the power voltage varies a lot.
 - e. In cars, boats, and other vehicles.
 - f. Locations such as kitchens where oil may splatter or where there is steam in the air.
 - g. Locations where equipment produces electromagnetic waves.
 - h. Places with an acid or alkaline mist.
 - i. Places where fallen leaves can accumulate or where weeds can grow.
- Take snow protection measures. Contact your dealer for the details of snow protection measures, such as the use of a snow protection hood.
- Do not attempt to do electrical work or grounding work unless you are licensed to do so. Consult with your dealer for electrical work and grounding work.
- Pay attention to operating sound. Be sure to use the following places:
 - a. Places that can sufficiently withstand the weight of the air conditioner or heat pump yet can suppress the operating sound and vibration.
 - b. Places where warm air from the air outlet of the outdoor unit or the operating sound of the outdoor unit does not annoy neighbors.
- Make sure that there are no obstacles close to the outdoor unit. Obstacles close to the outdoor unit may drop the performance of the outdoor unit or increase the operating sound of the outdoor unit.
- Consult your dealer if the air conditioner or heat pump in operation generates unusual noise.
- Make sure that the drainpipe is installed properly to drain water. If no water is discharged from the drainpipe while the air conditioner or heat pump is in the cooling mode, the drainpipe may be clogged with dust or dirt and water leakage from the indoor unit may occur. Stop operating the air conditioner or heat pump and contact your dealer.

⚠ NOTE

- Never press the button of the remote controller with a hard, pointed object. The remote controller may be damaged.
- Never pull or twist the electric wire of the remote controller. It may cause the unit to malfunction.
- Do not place appliances that produce open flames in places that are exposed to the airflow of the unit or under the indoor unit. It may cause incomplete combustion or deformation of the unit due to the heat.
- Do not expose the controller to direct sunlight. The LCD display can become discolored and may fail to display the data.
- Do not wipe the controller operation panel with benzene, thinner, chemical dust cloth, etc. The panel may get discolored or the coating can peel off. If it is heavily dirty, soak a cloth in water-diluted neutral detergent, squeeze it well and wipe the panel clean. Then wipe it with another dry cloth.

Names of Parts

Indoor Unit

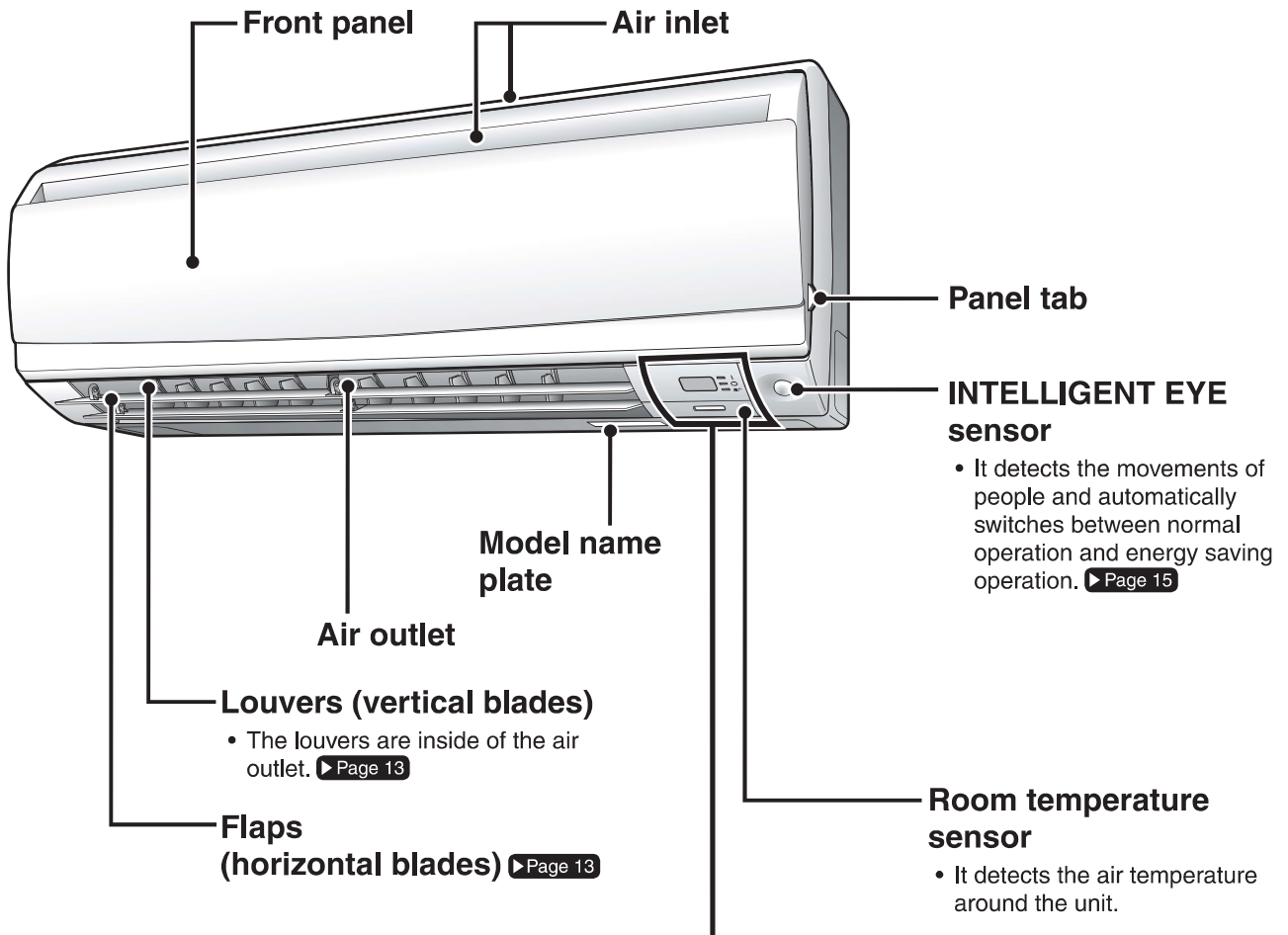

Display

Signal receiver

- It receives signals from the remote controller.
- When the unit receives a signal, you will hear a beep sound.

Case	Sound type
Operation start	beep-beep
Setting changed	beep
Operation stop	long beep

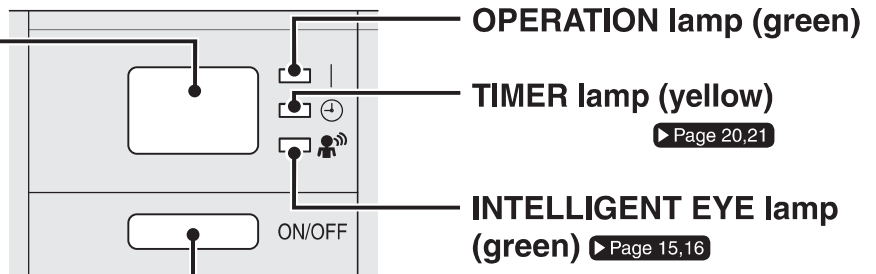

Indoor unit ON/OFF switch

- Press this switch once to start operation. Press once again to stop it.
- The operation mode refer to the following table.

Mode	Temperature setting	Airflow rate
AUTO	77°F (25°C)	AUTO

- This switch is useful when the remote controller is missing.

■ Open the front panel

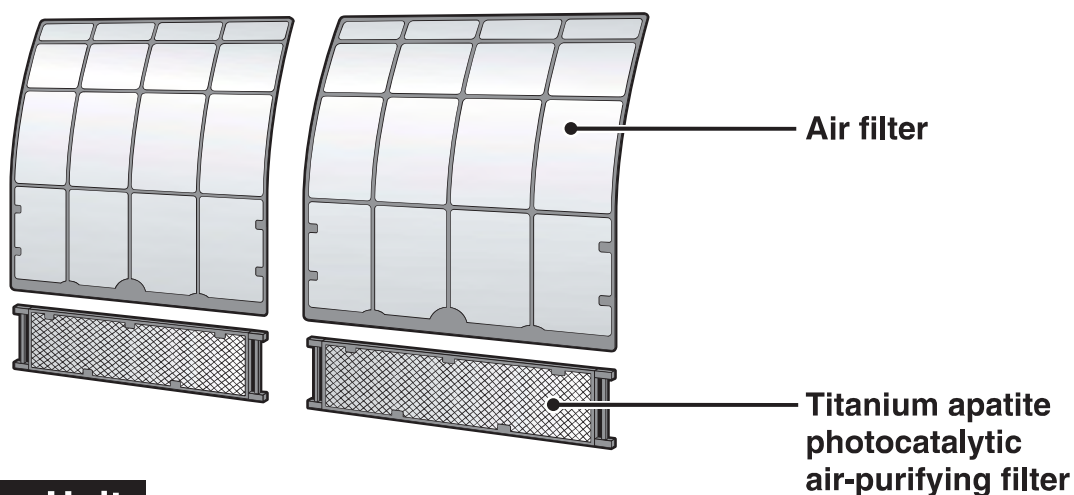
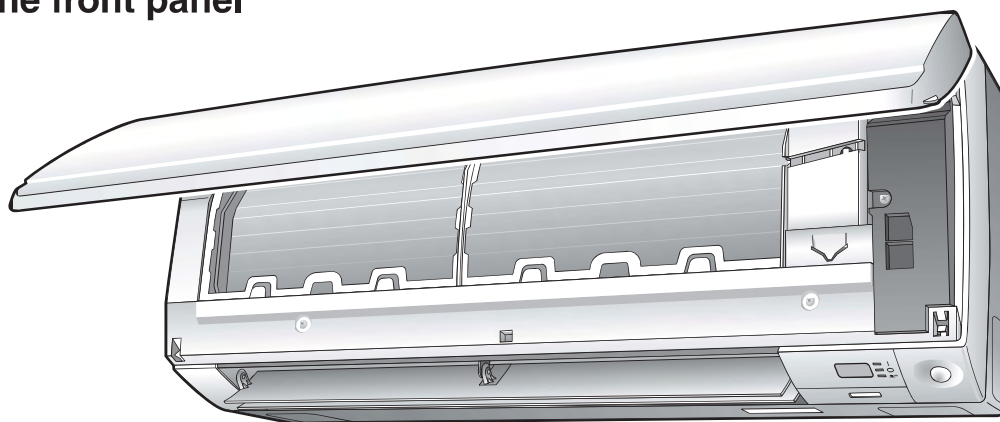

Outdoor Unit

- Appearance of the outdoor unit may differ from some models.

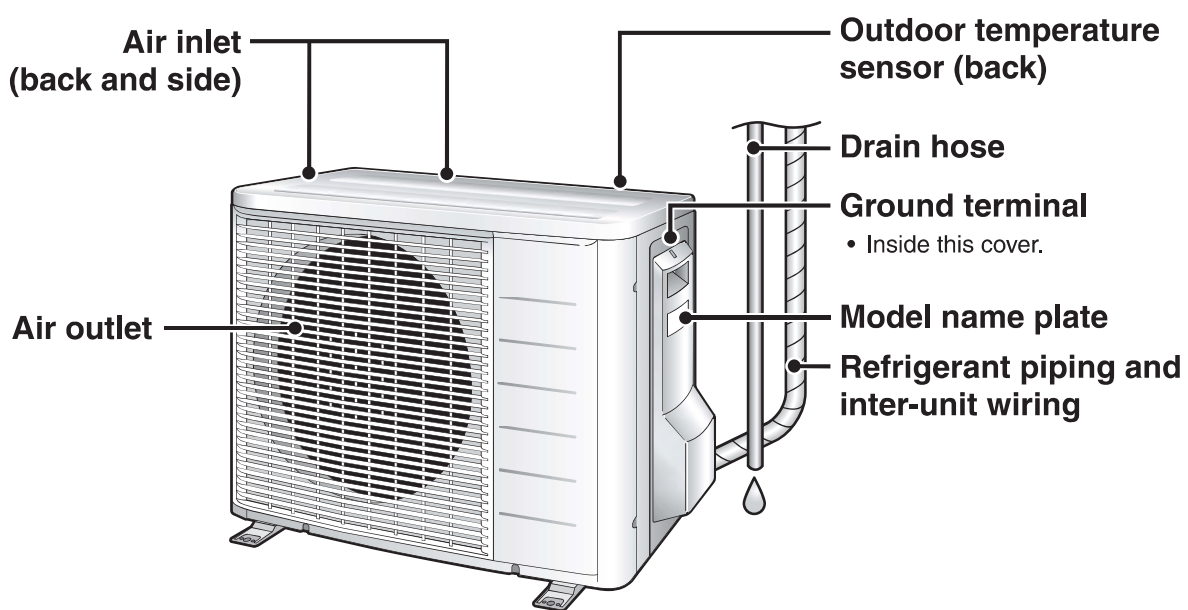

Names of Parts

Remote Controller

Signal transmitter

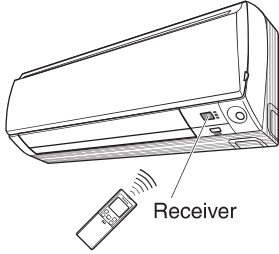

- To use the remote controller, aim the transmitter at the indoor unit. If there is anything to block signals between the unit and the remote controller, such as a curtain, the unit will not operate.
- Do not drop the remote controller. Do not get it wet.
- The maximum distance for communication is approximately 23ft (7m).

FAN setting button

- Selects the airflow rate setting. ▶ Page 14

POWERFUL button

- POWERFUL operation. ▶ Page 17

Display (LCD)

- Displays the current settings. (In this illustration, each section is shown with all its displays on for the purpose of explanation.)

TEMPERATURE adjustment buttons

- Changes the temperature setting. ▶ Page 12

ON/OFF button

- Press this button once to start operation. Press once again to stop it. ▶ Page 11

Front cover

- Open the front cover. ▶ Page 8

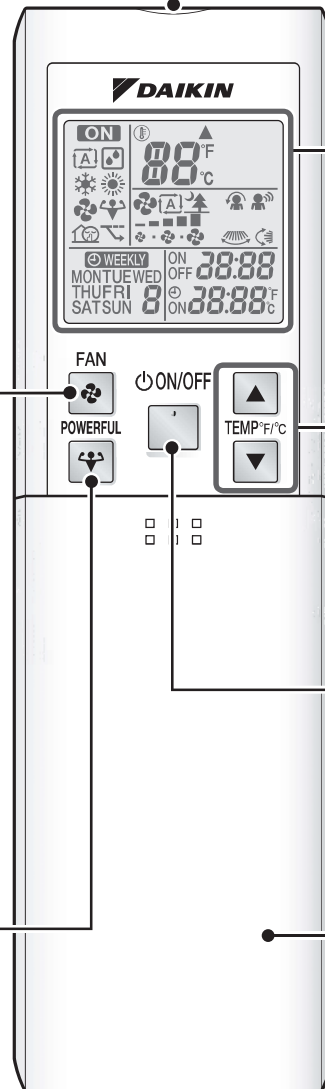

<ARC452A21>

■ Open the front cover

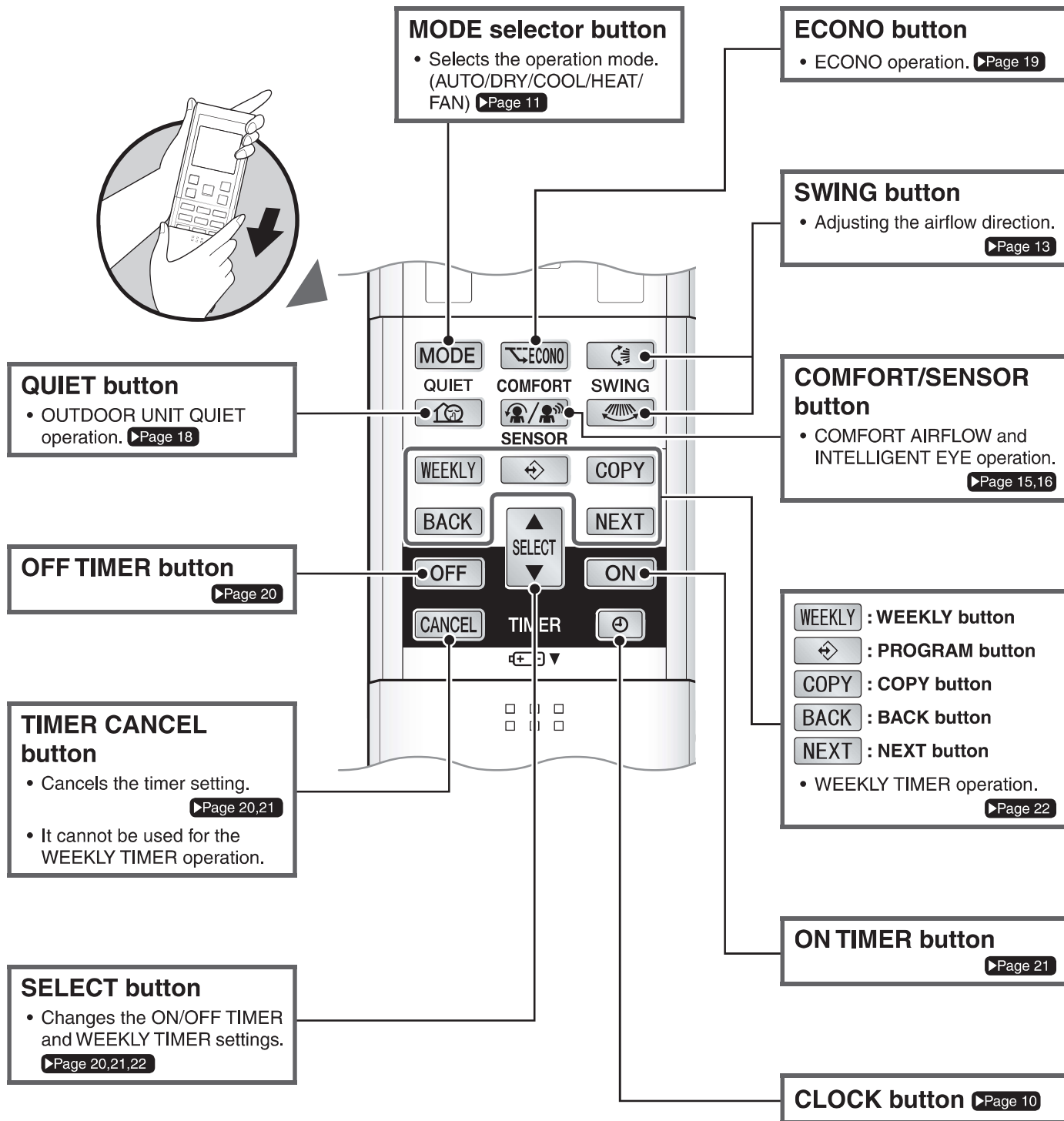

Preparation before Operation

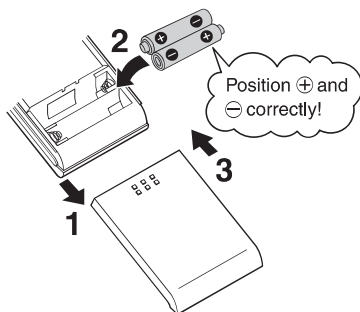

■ To set the batteries

1. Slide the front cover to take it off.
2. Set two dry batteries AAA.LR03 (alkaline).
3. Set the front cover as before.

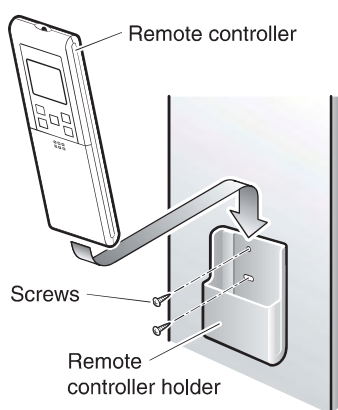

■ To fix the remote controller holder to a wall



1. Choose a place from where the signals reach the unit.
2. Fix the holder to a wall, a pillar, etc. with the screws supplied with the holder.
3. Place the remote controller in the remote controller holder.

■ Celsius/Fahrenheit display switch

- The Celsius or Fahrenheit display is selectable with the following buttons.

Press  and  simultaneously for 5 seconds.

- The temperature will be displayed in Fahrenheit if it is presently displayed in Celsius, and vice versa.

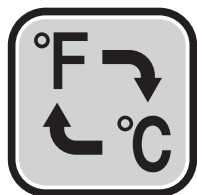

NOTE

■ Notes on batteries

- When replacing the batteries, use batteries of the same type, and replace both batteries at the same time.
- When the system is not used for a long time, take the batteries out.
- The batteries will last for approximately 1 year. If the remote controller display begins to fade and the degradation of reception performance occurs within a year, however, replace both batteries with new, size AAA.LR03 (alkaline).
- The attached batteries are provided for the initial use of the system.
The usable period of the batteries may be short depending on the manufactured date of the air conditioner.

■ Notes on remote controller

- Never expose the remote controller to direct sunlight.
- Dust on the signal transmitter or receiver will reduce the sensitivity. Wipe off dust with a soft cloth.
- Signal communication may be disabled if an electronic-starter-type fluorescent lamp (such as inverter-type lamps) is in the room. Consult the shop if that is the case.
- If the remote controller signals happen to operate another appliance, move that appliance somewhere else, or consult the service shop.

■ Celsius/Fahrenheit display change function of remote controller

- The set temperature may increase when the display is changed to Celsius from Fahrenheit, because a fraction of 0.5°C is rounded up.
- Example: A set temperature of 65°F (equivalent to 18.5°C) will be converted into 19°C.
When the display is changed to Fahrenheit again, the set temperature will be converted into 66°F (equivalent to 19°C) instead of the original set temperature (65°F) but a set temperature of 66°F (equivalent to 19°C) will be converted into 19°C with no temperature change.
- A reception sound will go off for the transmission of set temperature to the indoor unit at the time of setting the Celsius/Fahrenheit display change function.

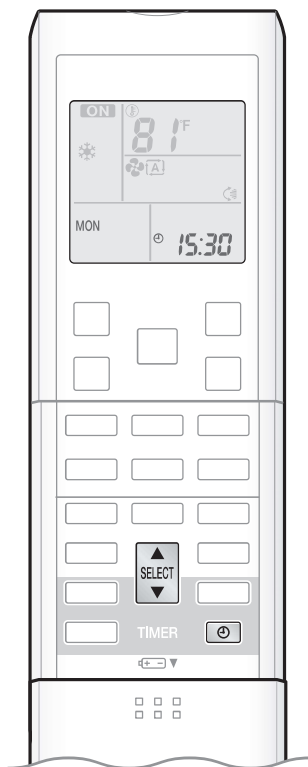

■ Turn the breaker on

- After the power is turned on, the flaps of the indoor unit open and close once to set the reference position.

■ To set the clock

1. Press .



- "0:00" is displayed.
- "MON" and "⌚" blink.

2. Press to set the current day of the week.

3. Press .



- "⌚" blinks.

4. Press to set the clock to the present time.

- Holding down ▲ or ▼ rapidly increases or decreases the time display.

5. Press .

- Point the remote controller at the indoor unit when pressing the buttons.



- "⌚" blinks.



AUTO · DRY · COOL · HEAT · FAN Operation

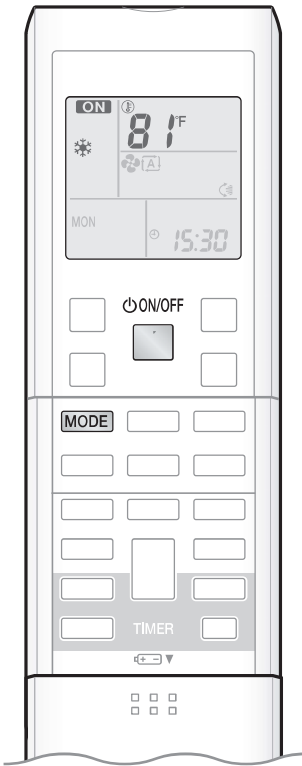

The air conditioner operates with the operation mode of your choice. From the next time on, the air conditioner will operate with the same operation mode.

To start operation

1. Press **MODE** and select an operation mode.

- Each pressing of the button advances the mode setting in sequence.

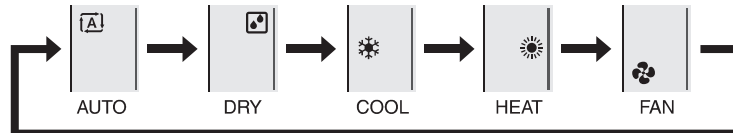

2. Press **ON/OFF**.

- “**ON**” is displayed on the LCD.
- The OPERATION lamp lights green.



Display

To stop operation

Press **ON/OFF** again.



- “**ON**” is no longer displayed on the LCD.
- The OPERATION lamp goes off.

NOTE

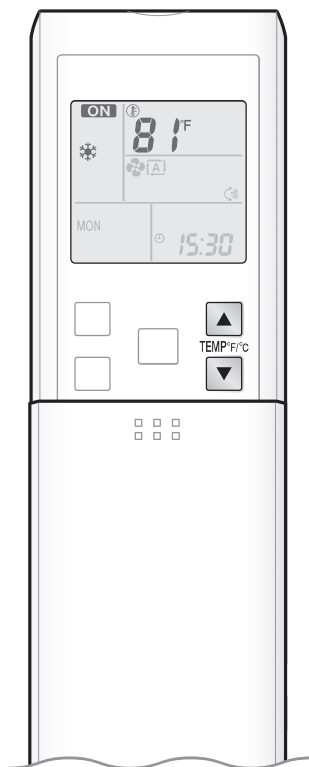
MODE	Notes on each operation mode
HEAT	<ul style="list-style-type: none"> • Since this air conditioner heats the room by taking heat from outdoor air to indoors, the heating capacity becomes smaller in lower outdoor temperatures. If the heating effect is insufficient, it is recommended to use another heating appliance in combination with the air conditioner. • The heat pump system heats the room by circulating hot air around all parts of the room. After the start of HEAT operation, it takes some time before the room gets warmer. • In HEAT operation, frost may occur on the outdoor unit and lower the heating capacity. In that case, the system switches into defrosting operation to take away the frost. • During defrosting operation, hot air does not flow out of indoor unit.
COOL	<ul style="list-style-type: none"> • This air conditioner cools the room by releasing the heat in the room outside. Therefore, the cooling performance of the air conditioner may be degraded if the outdoor temperature is high.
DRY	<ul style="list-style-type: none"> • The computer chip works to rid the room of humidity while maintaining the temperature as much as possible. It automatically controls temperature and airflow rate, so manual adjustment of these functions is unavailable.
AUTO	<ul style="list-style-type: none"> • In AUTO operation, the system selects an appropriate operation mode (COOL or HEAT) based on the room and outside temperatures and starts the operation. • The system automatically reselects setting at a regular interval to bring the room temperature to user-setting level.
FAN	<ul style="list-style-type: none"> • This mode is valid for fan only.



■ To change the temperature setting

Press  or  .

- The displayed items on the LCD will change whenever either one of the buttons is pressed.

COOL operation	HEAT operation	AUTO operation	DRY or FAN operation
64-90°F (18-32°C)	50-86°F (10-30°C)	64-86°F (18-30°C)	The temperature setting cannot be changed.
Press ▲ to raise the temperature and press ▼ to lower the temperature.			

■ Operating conditions

■ Recommended temperature setting

- For cooling: 78-82°F (26-28°C)
- For heating: 68-75°F (20-24°C)

■ Tips for saving energy

- Be careful not to cool (heat) the room too much.
Keeping the temperature setting at a moderate level helps save energy.
- Cover windows with a blind or a curtain.
Blocking sunlight and air from outdoors increases the cooling (heating) effect.
- Clogged air filters cause inefficient operation and waste energy. Clean them once in about every 2 weeks. [▶Page 32](#)

■ Notes on the operating conditions

- The air conditioner always consumes a small amount of electricity even while it is not operating.
- If you are not going to use the air conditioner for a long period, for example in spring or autumn, turn the breaker off.
- Use the air conditioner in the following conditions.

MODE	Operating conditions	If operation is continued out of this range
COOL	Outdoor temperature: 50-115°F (10-46°C) Indoor temperature: 64-90°F (18-32°C) Indoor humidity: 80% max.	<ul style="list-style-type: none"> • A safety device may work to stop the operation. (In multi system, it may work to stop the operation of the outdoor unit only.) • Condensation may occur on the indoor unit and drip.
HEAT	Outdoor temperature: [2/3MXL]: -13-75°F (-25-24°C) [Other models]: 5-75°F (-15-24°C) Indoor temperature: 50-86°F (10-30°C)	<ul style="list-style-type: none"> • A safety device may work to stop the operation.
DRY	Outdoor temperature: 50-115°F (10-46°C) Indoor temperature: 64-90°F (18-32°C) Indoor humidity: 80% max.	<ul style="list-style-type: none"> • A safety device may work to stop the operation. • Condensation may occur on the indoor unit and drip.

- Operation outside this humidity or temperature range may cause a safety device to disable the system.



Adjusting the Airflow Direction and Rate

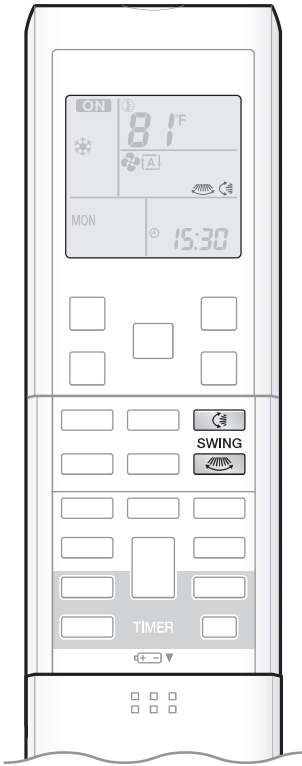

You can adjust the airflow direction to increase your comfort.

■ To start auto swing

Upper and lower airflow direction

Press .

- “” is displayed on the LCD.
- The flaps (horizontal blades) will begin to swing.

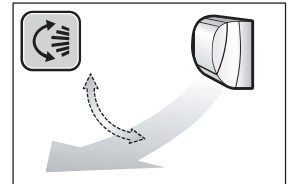

Right and left airflow direction



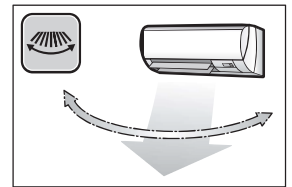

Press .

- “” is displayed on the LCD.
- The louvers (vertical blades) will begin to swing.



The 3-D airflow direction

Press  and .

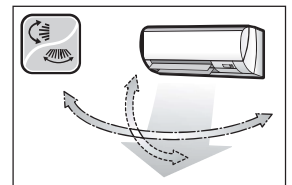

- “” and “” are displayed on the LCD.
- The flaps and louvers move in turn.
- To cancel 3-D airflow, press either  or  again. The flaps or louvers will stop moving.



■ To set the flaps or louvers at the desired position

- This function is effective while flaps or louvers are in auto swing mode.

Press  and  when the flaps or louvers reach the desired position.

- In the 3-D airflow, the flaps and louvers move in turn.
- “” or “” disappears from the LCD.

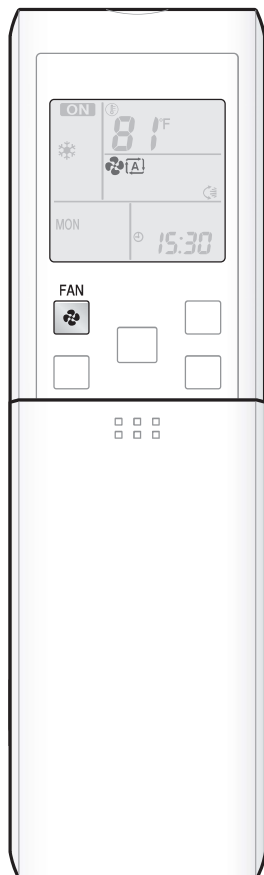

■ To adjust the airflow rate setting

Press

- Each pressing of advances the airflow rate setting in sequence.

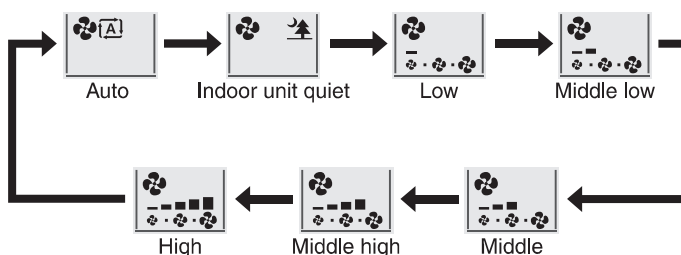

- When the airflow is set to “
- In indoor unit quiet operation, the airflow rate is set to a weak level.
- In DRY operation, the airflow rate setting cannot be changed.

NOTE

■ Notes on the angles of the flaps

- The flaps swinging range depends on the operation. (See the figure.)

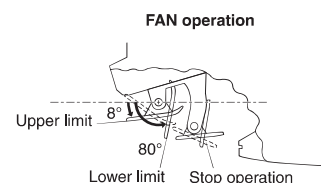
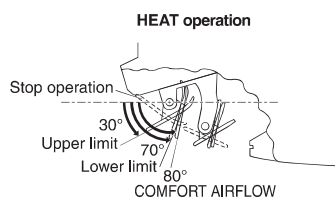
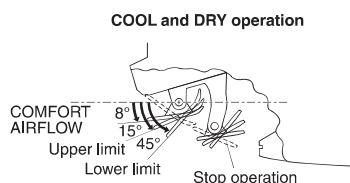

■ Note on 3-D airflow

- Using 3-D airflow circulates cold air, which tends to collect at the bottom of the room, and hot air, which tends to collect near the ceiling, throughout the room, preventing areas of cold and hot developing.

■ Note on airflow rate setting

- At smaller airflow rates, the cooling (heating) effect is also smaller.

CAUTION

- Always use a remote controller to adjust the angles of the flaps and louvers.
 - If you attempt to move the flaps and louvers forcibly by hand when they are swinging, the mechanism may be damaged.
 - Inside the air outlet, a fan is rotating at a high speed.



COMFORT AIRFLOW / INTELLIGENT EYE Operation

COMFORT AIRFLOW operation

The flow of air will be in the upward direction while in COOL operation and in the downward direction while in HEAT operation, which will provide a comfortable wind that will not come in direct contact with people.

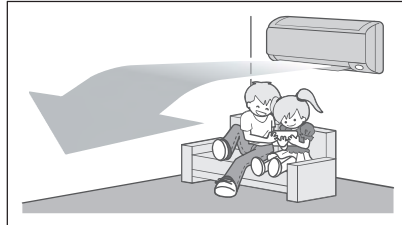

COOL operation

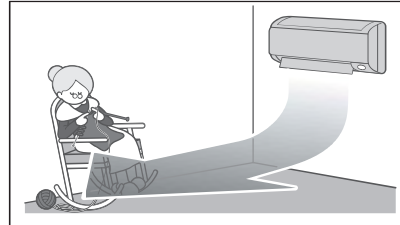

HEAT operation

INTELLIGENT EYE operation

“INTELLIGENT EYE” is the infrared sensor which detects the human movement.

If no one is in the room for more than 20 minutes, the operation automatically changes to energy saving operation.

[Example]

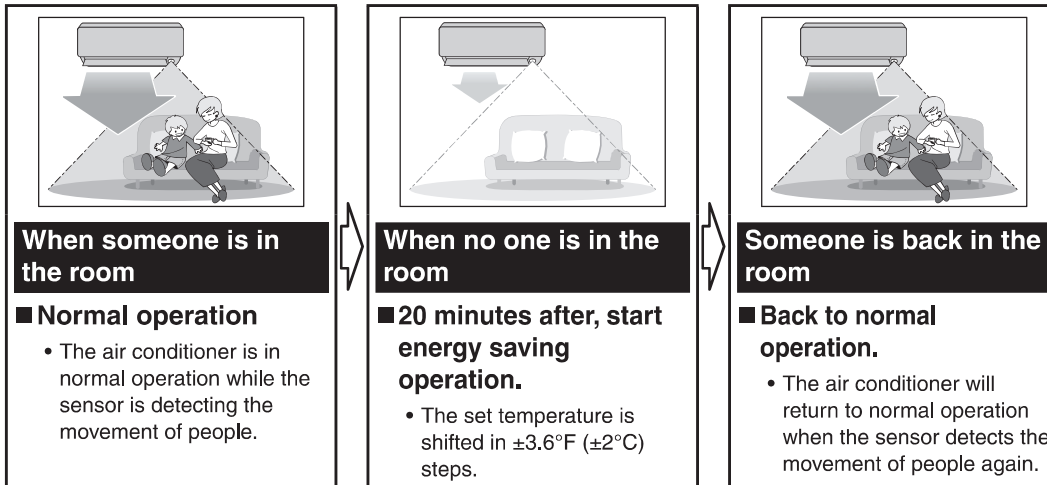

INTELLIGENT EYE operation is useful for energy saving

Energy saving operation

- If no presence is detected in the room for 20 minutes, the energy saving operation will start, and the INTELLIGENT EYE lamp goes off. If human movement is detected again, the INTELLIGENT EYE lamp lights up and energy saving operation terminates.
- This operation changes the temperature -3.6°F (-2°C) in HEAT / $+3.6^{\circ}\text{F}$ ($+2^{\circ}\text{C}$) in COOL / $+3.6^{\circ}\text{F}$ ($+2^{\circ}\text{C}$) in DRY operation from set temperature. When the room temperature exceeds 86°F (30°C), the operation changes the temperature $+1.8^{\circ}\text{F}$ ($+1^{\circ}\text{C}$) in COOL / $+1.8^{\circ}\text{F}$ ($+1^{\circ}\text{C}$) in DRY operation from set temperature.
- This operation decreases the airflow rate slightly in FAN mode only.

Combination COMFORT AIRFLOW and INTELLIGENT EYE operation

The air conditioner can go into operation with the COMFORT AIRFLOW and INTELLIGENT EYE functions combined.

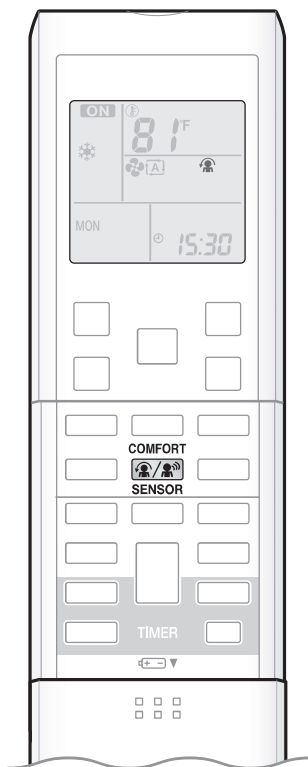



■ To start operation

Press  and select the desired mode.

- Each time the  is pressed a different setting option is displayed on the LCD.
- When INTELLIGENT EYE is selected, the INTELLIGENT EYE lamp lights green.



Display

- By selecting “ ” from the following icons, the air conditioner will be in COMFORT AIRFLOW operation combined with INTELLIGENT EYE operation.

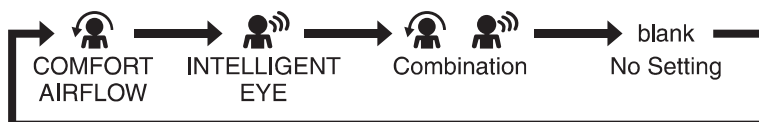

- When the flaps (horizontal blades) are swinging, selecting any of the modes above will cause the flaps (horizontal blades) to stop.

■ To cancel operation

Press  and select “blank” on the LCD.

- If the INTELLIGENT EYE operation was being used, the INTELLIGENT EYE lamp goes off.

NOTE

■ Notes on COMFORT AIRFLOW operation

- The position of the flaps will change, preventing air from blowing directly on the occupants of the room.
- POWERFUL operation and COMFORT AIRFLOW operation cannot be used at the same time. Priority is given to the function of whichever button is pressed last.
- The airflow rate will be set to AUTO. If the upper and lower airflow direction is selected, the COMFORT AIRFLOW function will be canceled.

■ Notes on INTELLIGENT EYE operation

- Application range is as follows.

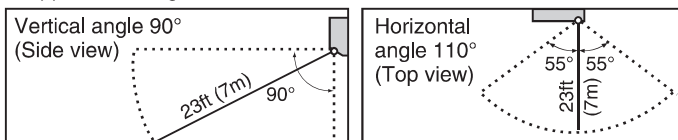

- Sensor may not detect moving objects further than 23ft (7m) away. (Check the application range)
- Sensor detection sensitivity changes according to indoor unit location, the speed of passersby, temperature range, etc.
- The sensor also mistakenly detects pets, sunlight, fluttering curtains and light reflected off of mirrors as passersby.
- INTELLIGENT EYE operation will not go on during POWERFUL operation.
- NIGHT SET mode [▶Page 20](#) will not go on during use of INTELLIGENT EYE operation.

■ Notes on combination of COMFORT AIRFLOW operation and INTELLIGENT EYE operation

- The airflow rate will be set to AUTO. If the upper and lower airflow direction is selected, the COMFORT AIRFLOW operation will be canceled. Priority is given to the function of whichever button is pressed last.

CAUTION

- Do not place large objects near the sensor.
Also keep heating units or humidifiers outside the sensor's detection area. This sensor can detect undesirable objects.
- Do not hit or violently push the INTELLIGENT EYE sensor. This can lead to damage and malfunction.



POWERFUL Operation

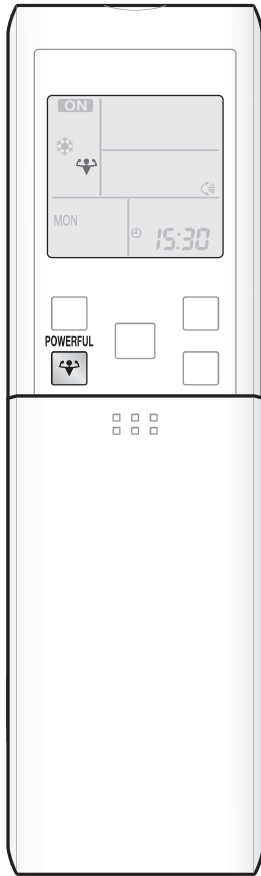

POWERFUL operation quickly maximizes the cooling (heating) effect in any operation mode. You can get the maximum capacity.

■ To start POWERFUL operation

Press  during operation.

- POWERFUL operation ends in 20 minutes. Then the system automatically operates again with the previous settings which were used before POWERFUL operation.
- “” is displayed on the LCD.

■ To cancel POWERFUL operation

Press  again.

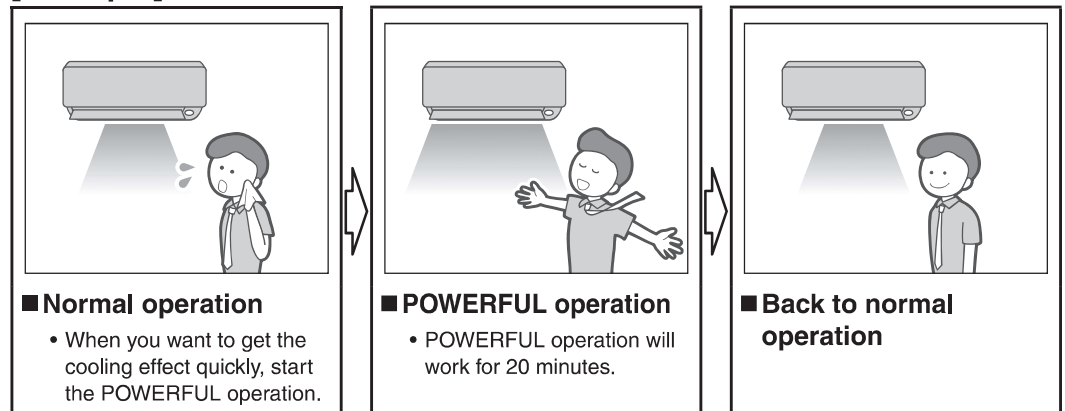

- “” is no longer displayed on the LCD.

[Example]



NOTE

■ Notes on POWERFUL operation

- When using POWERFUL operation, there are some functions which are not available.
- POWERFUL operation cannot be used together with ECONO, COMFORT AIRFLOW or OUTDOOR UNIT QUIET operation. Priority is given to the function of whichever button is pressed last.
- POWERFUL operation can only be set when the unit is running. Pressing  causes the settings to be canceled, and “” is no longer displayed on the LCD.
- POWERFUL operation will not increase the capacity of the air conditioner if the air conditioner is already in operation with its maximum capacity demonstrated.
- **In COOL, HEAT and AUTO operation**
To maximize the cooling (heating) effect, the capacity of outdoor unit increases and the airflow rate becomes fixed at the maximum setting.
The temperature and airflow settings cannot be changed.
- **In DRY operation**
The temperature setting is lowered by 4.5°F (2.5°C) and the airflow rate is slightly increased.
- **In FAN operation**
The airflow rate is fixed to the maximum setting.



OUTDOOR UNIT QUIET Operation

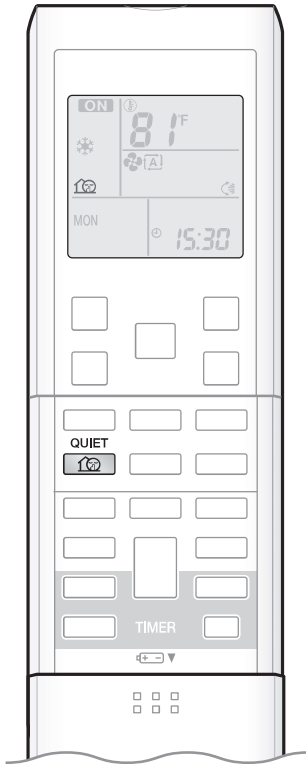

OUTDOOR UNIT QUIET operation lowers the noise level of the outdoor unit by changing the frequency and fan speed on the outdoor unit. This function is convenient during the night.

■ To start OUTDOOR UNIT QUIET operation

Press .

- “” is displayed on the LCD.

■ To cancel OUTDOOR UNIT QUIET operation

Press  again.

- “” is no longer displayed on the LCD.

[Example] Using the OUTDOOR UNIT QUIET operation during the night.

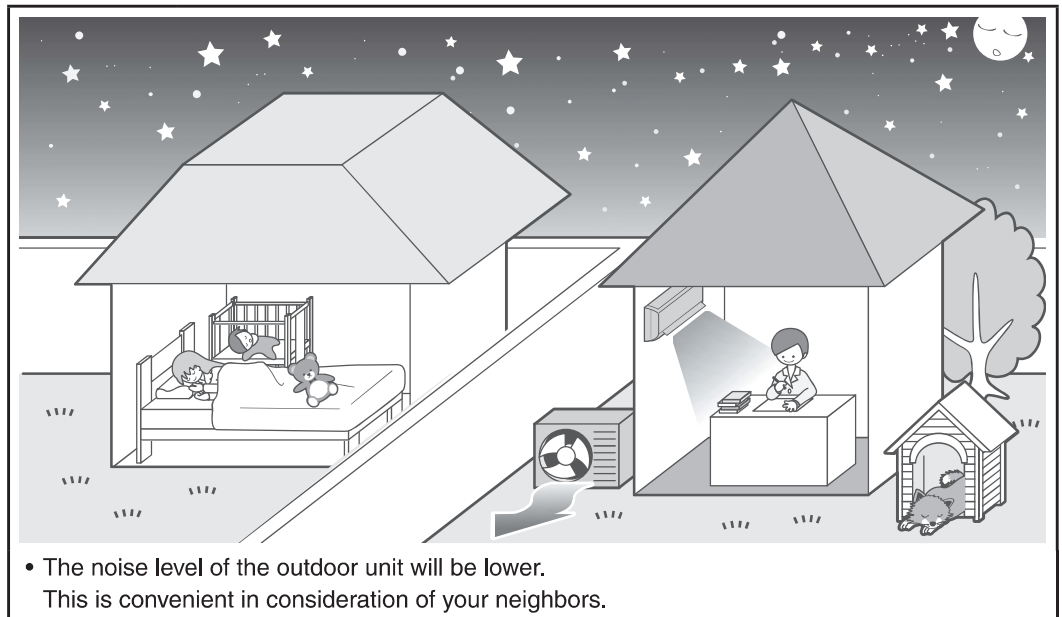

- The noise level of the outdoor unit will be lower.
This is convenient in consideration of your neighbors.

NOTE

■ Notes on OUTDOOR UNIT QUIET operation

- If using a multi system, the OUTDOOR UNIT QUIET operation will work only when this function is set on all operated indoor units. However, if using priority room setting, refer to “Note for multi system”. ▶Page 28
- This function is available in COOL, HEAT, and AUTO operation.
This is not available in FAN and DRY operation.
- POWERFUL operation and OUTDOOR UNIT QUIET operation cannot be used at the same time.
Priority is given to the function of whichever button is pressed last.
- Even the operation is stopped using the remote controller or the indoor unit ON/OFF switch when using OUTDOOR UNIT QUIET operation, “” will remain on the remote controller display.
- OUTDOOR UNIT QUIET operation will drop neither the frequency nor fan speed if they have been already dropped low enough.



ECONO Operation

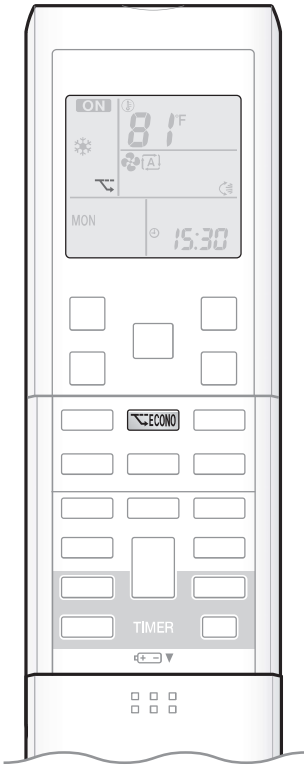

ECONO operation is a function which enables efficient operation by limiting the maximum power consumption value. This function is useful for cases in which attention should be paid to ensure a circuit breaker will not trip when the product runs alongside other appliances.

■ To start ECONO operation

Press during operation.

- “” is displayed on the LCD.

■ To cancel ECONO operation

Press again.

- “” is no longer displayed on the LCD.

[Example]

Normal operation



- In case the air conditioner and other appliances which require high power consumption are used at same time, a circuit breaker may trip if the air conditioner operate with its maximum capacity.

ECONO operation



- The maximum power consumption of the air conditioner is limited by using ECONO operation. The circuit breaker is unlikely to trip even if the air conditioner and other appliances are used at same time.

Running current and power consumption

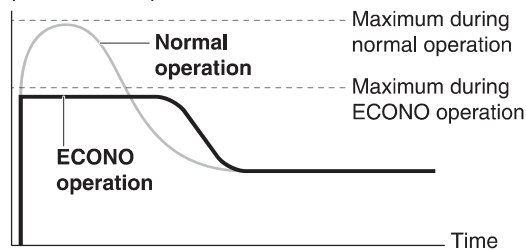

From start up until set temperature is reached

- This diagram is a representation for illustrative purposes only.

The maximum running current and power consumption of the air conditioner in ECONO operation vary with the connecting outdoor unit.

NOTE

■ Notes on ECONO operation

- ECONO operation can only be set when the unit is running. Pressing causes the settings to be canceled, and “” is no longer displayed on the LCD.
- ECONO operation functions in AUTO, COOL, DRY, and HEAT operation.
- POWERFUL and ECONO operation cannot be used at the same time. Priority is given to the function of whichever button is pressed last.
- If the level of power consumption is already low, ECONO operation will not drop the power consumption.



OFF TIMER Operation

Timer functions are useful for automatically switching the air conditioner on or off at night or in the morning. You can also use OFF TIMER and ON TIMER in combination.

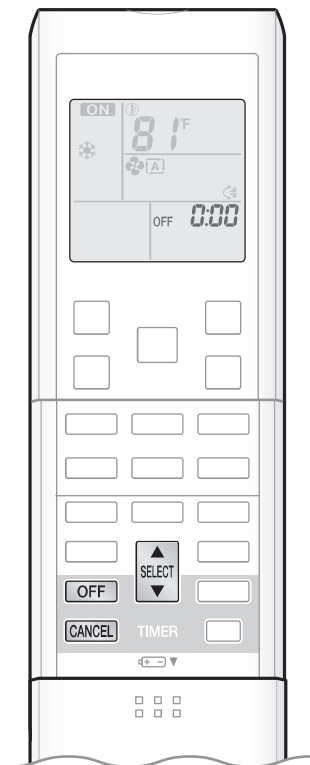

■ To use OFF TIMER operation

- Check that the clock is correct.
If not, set the clock to the present time. ▶Page 10

1. Press OFF.



“0:00” is displayed on the LCD.
“OFF” blinks.

- “⊕” is no longer displayed on the LCD.

2. Press SELECT until the time setting reaches the point you like.



- Each pressing of either button increases or decreases the time setting by 10 minutes. Holding down either button changes the time setting rapidly.

3. Press OFF again.

- “OFF” and setting time are displayed on the LCD.
- The TIMER lamp lights yellow.



Display

■ To cancel OFF TIMER operation

Press CANCEL.

- “OFF” and setting time are no longer displayed on the LCD.
- “⊕” and day of the week are displayed on the LCD.
- The TIMER lamp goes off.

NOTE

■ Notes on TIMER operation

- When TIMER is set, the present time is not displayed.
- Once you set ON/OFF TIMER, the time setting is kept in the memory. The memory is canceled when remote controller batteries are replaced.
- When using the ON/OFF TIMER to start/stop operation, the actual operation start/stop time may differ from the time set. (Maximum of about 10 minutes)

■ NIGHT SET mode

- When the OFF TIMER is set, the air conditioner automatically adjusts the temperature setting (0.9°F (0.5°C) up in COOL, 3.6°F (2.0°C) down in HEAT) to prevent excessive cooling (heating) for your pleasant sleep.



ON TIMER Operation

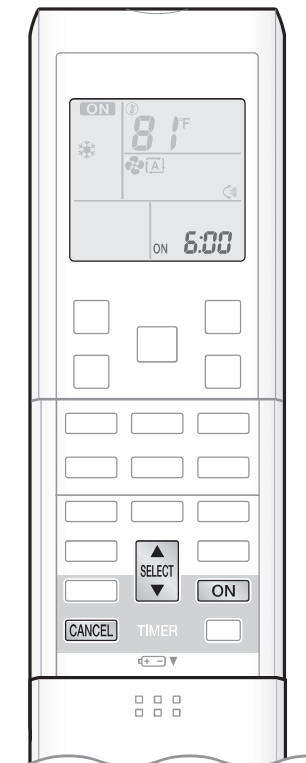

■ To use ON TIMER operation

- Check that the clock is correct.
If not, set the clock to the present time. ▶Page 10

1. Press **ON**.

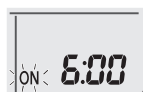

“6:00” is displayed on the LCD.
“ON” blinks.

- “⊕” and day of the week are no longer displayed on the LCD.

2. Press **SELECT** until the time setting reaches the point you like.

- Each pressing of either button increases or decreases the time setting by 10 minutes.
Holding down either button changes the setting rapidly.

3. Press **ON** again.

- “ON” and setting time are displayed on the LCD.
- The TIMER lamp lights yellow.



Display

■ To cancel ON TIMER operation

Press **CANCEL**.

- “ON” and setting time are no longer displayed on the LCD.
- “⊕” and day of the week are displayed on the LCD.
- The TIMER lamp goes off.

■ To combine ON TIMER and OFF TIMER

- A sample setting for combining the 2 timers is shown below.

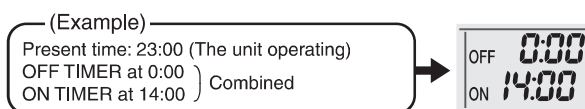

NOTE

■ In the following cases, set the timer again.

- After a breaker has turned off.
- After a power failure.
- After replacing batteries in the remote controller.



WEEKLY TIMER Operation

Up to 4 timer settings can be saved for each day of the week. It is convenient if the WEEKLY TIMER is set according to the family's life style.

■ Using in these cases of WEEKLY TIMER

Example: The same timer settings are made for the week from Monday through Friday while different timer settings are made for the weekend.

<p>[Monday]</p>	<p>Make timer settings up to programs 1-4. ▶Page 23</p>
<p>[Tuesday to Friday]</p>	<p>Use the copy mode to make settings for Tuesday to Friday, because these settings are the same as those for Monday. ▶Page 25</p>
<p>[Saturday]</p>	<p>No timer settings</p>
<p>[Sunday]</p>	<p>Make timer settings up to programs 1-4. ▶Page 23</p>

- Up to 4 reservations per day and 28 reservations per week can be set in the WEEKLY TIMER. The effective use of the copy mode ensures ease of making reservations.
- The use of ON-ON-ON-ON settings, for example, makes it possible to schedule operating mode and set temperature changes. Furthermore, by using OFF-OFF-OFF-OFF settings, only the turn off time of each day can be set. This will turn off the air conditioner automatically if the user forgets to turn it off.

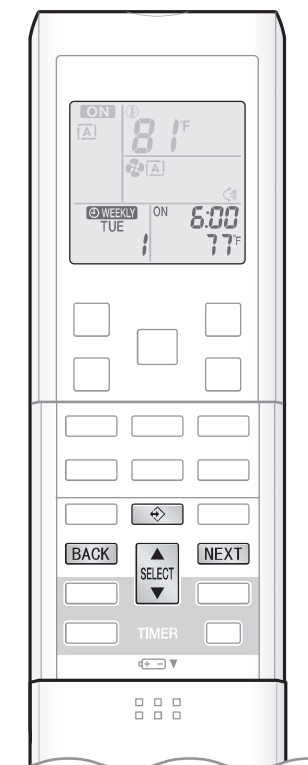

6. Press to select the desired time.

- The time can be set between 0:00 and 23:50 in 10 minute intervals.
- To return to the ON/OFF TIMER mode setting, press **BACK**.
- Go to **STEP 9** when setting the OFF TIMER.

7. Press .

- The time will be set.
- “**WEEKLY**” and the temperature blink.

8. Press to select the desired temperature.

- The temperature can be set between 50°F (10°C) and 90°F (32°C).
Cooling: The unit operates at 64°F (18°C) even if it is set at 50°F (10°C) to 63°F (17°C).
Heating: The unit operates at 86°F (30°C) even if it is set at 87°F (31°C) to 90°F (32°C).
- To return to the time setting, press **BACK**.
- The set temperature is only displayed when the mode setting is on.

9. Press .

- The temperature will be set and go to the next reservation setting.
- To continue further settings, repeat the procedure from **STEP 4**.

10. Press to complete the setting.

- Be sure to direct the remote controller toward the indoor unit and check for a receiving tone and flashing the OPERATION lamp.
- “**WEEKLY**” is displayed on the LCD and WEEKLY TIMER operation is activated.
- The TIMER lamp lights yellow.



Display

- A reservation made once can be easily copied and the same settings used for another day of the week. Refer to **Copy mode**. ▶Page 25

NOTE

■ Notes on WEEKLY TIMER operation

- Do not forget to set the clock on the remote controller first. ▶Page 10
- The day of the week, ON/OFF TIMER mode, time and set temperature (only for ON TIMER mode) can be set with WEEKLY TIMER. Other settings for ON TIMER are based on the settings just before the operation.
- Both WEEKLY TIMER and ON/OFF TIMER operation cannot be used at the same time. The ON/OFF TIMER operation has priority if it is set while WEEKLY TIMER is still active. The WEEKLY TIMER will go into standby state, and “**WEEKLY**” will be no longer displayed on the LCD. When ON/OFF TIMER is up, the WEEKLY TIMER will automatically become active.
- Only the time and set temperature with the WEEKLY TIMER are sent with . Set the WEEKLY TIMER only after setting the operation mode, the airflow rate and the airflow direction ahead of time.
- Shutting the breaker off, power failure, and other similar events will render operation of the indoor unit's internal clock inaccurate. Reset the clock. ▶Page 10
- The **BACK** can be used only for the time and temperature settings. It cannot be used to go back to the reservation number.



WEEKLY TIMER Operation

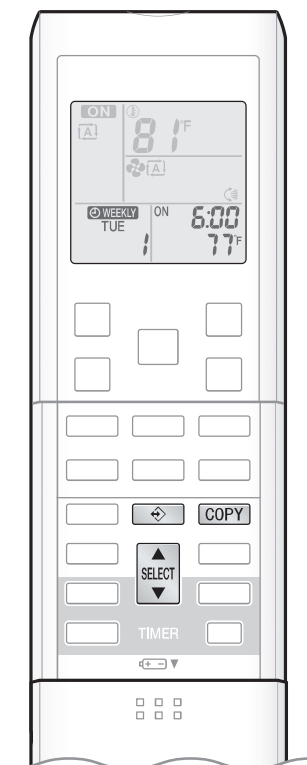

Copy mode

- A reservation made once can be copied to another day of the week. The whole reservation of the selected day of the week will be copied.

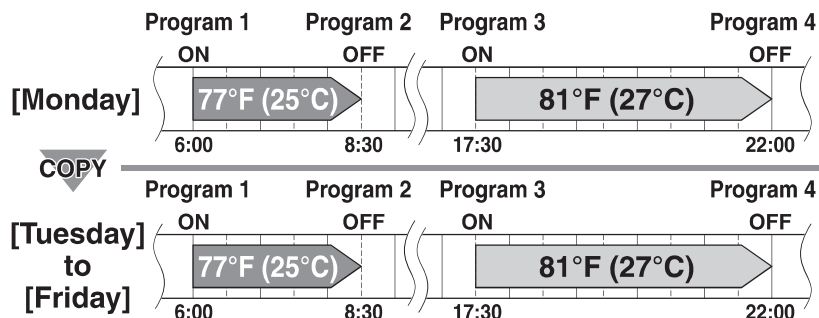

Setting Displays

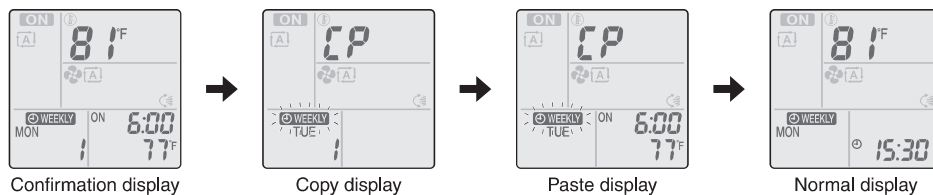

1. Press .
2. Press to confirm the day of the week to be copied.
3. Press .

 - The whole reservation of the selected day of the week will be copied.

4. Press to select the destination day of the week.
5. Press .

 - The reservation will be copied to the selected day of the week. The whole reservation of the selected day of the week will be copied.
 - To continue copying the settings to other days of the week, repeat **STEP 4** and **STEP 5**.

6. Press to complete the setting.
 - “ WEEKLY” is displayed on the LCD and WEEKLY TIMER operation is activated.

NOTE

■ Note on COPY MODE

- The entire reservation of the source day of the week is copied in the copy mode.

In the case of making a reservation change for any day of the week individually after copying the content of weekly reservations, press and change the settings in the steps of **Setting mode**. Page 23

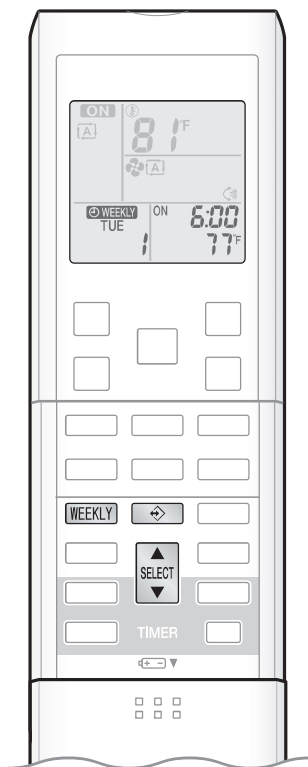

■ Confirming a reservation

- The reservation can be confirmed.

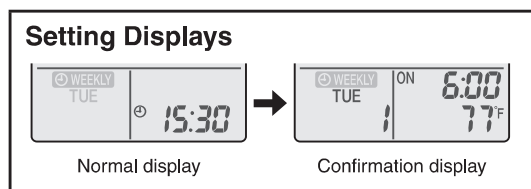

1. Press .

- The day of the week and the reservation number of current day will be displayed.

2. Press to select the day of the week and the reservation number to be confirmed.

- Pressing  displays the reservation details.
- To change the confirmed reserved settings, select the reservation number and press **NEXT** .

The mode is switched to setting mode. Go to **Setting mode** **STEP 4.**  Page 23

3. Press to exit confirming mode.

- “**WEEKLY**” is displayed on the LCD and WEEKLY TIMER operation is activated.
- The TIMER lamp lights yellow.



Display

■ To deactivate WEEKLY TIMER operation

Press **WEEKLY** while “**WEEKLY**” is displayed on the LCD.

- “**WEEKLY**” will be no longer displayed on the LCD.
- The TIMER lamp goes off.
- To reactivate the WEEKLY TIMER operation, press **WEEKLY** again.
- If a reservation deactivated with **WEEKLY** is activated once again, the last reservation mode will be used.



WEEKLY TIMER Operation

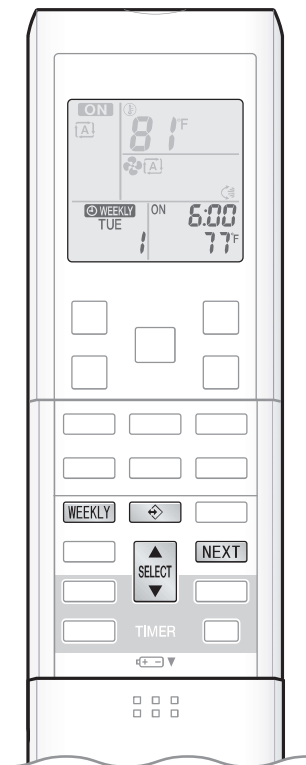

■ To delete reservations

The individual reservation

1. Press .
 - The day of the week and the reservation number will be displayed.
 2. Press to select the day of the week and the reservation number to be deleted.
 3. Press .
 - “ WEEKLY” and “ON” or “OFF” blink.
 4. Press and select “blank”.
 - Pressing changes ON/OFF TIMER mode.
 - The reservation will be no setting with selecting “blank”.
- ON TIMER → OFF TIMER → blank
5. Press .
 - The selected reservation will be deleted.
 6. Press .
 - If there are still other reservations, WEEKLY TIMER operation will be activated.

The reservations for each day of the week

- This function can be used for deleting reservations for each day of the week.
 - It can be used while confirming or setting reservations.
1. Press .
 - The day of the week and the reservation number will be displayed.
 2. Press to select the day of the week to be deleted.
 3. Hold for 5 seconds.
 - The reservation of the selected day of the week will be deleted.
 4. Press .
 - If there are still other reservations, WEEKLY TIMER operation will be activated.

All reservations

Hold for 5 seconds while normal display.

- Be sure to direct the remote controller toward the indoor unit and check for a receiving tone.
- This operation is not effective on the setting display of WEEKLY TIMER.
- All reservations will be deleted.

Note for Multi System

Multi system has one outdoor unit connected to multiple indoor units.

■ Selecting the operation mode

With the priority room setting present but inactive or not present.

When more than one indoor unit is operating, priority is given to the first unit that was turned on.

In this case, set the units that are turned on later to the same operation mode as the first unit.

Otherwise, they will enter the standby state, and the OPERATION lamp will flash: this does not indicate malfunction.

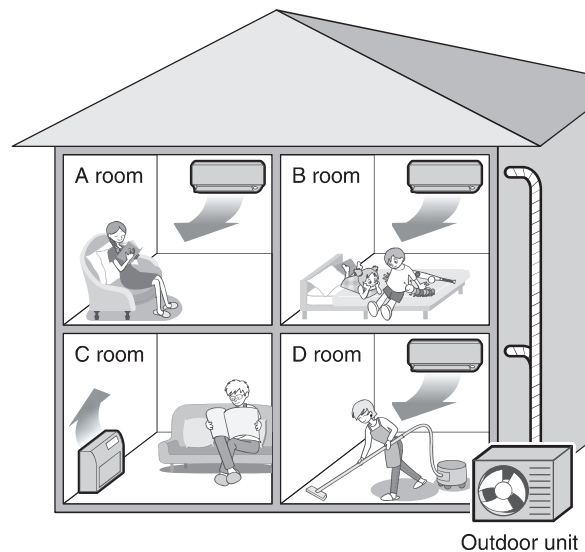

NOTE

■ Notes on operation mode for multi system

- COOL, DRY and FAN operation may be used at the same time.
- AUTO operation automatically selects COOL operation or HEAT operation based on the room temperature. Therefore, AUTO operation is available when selecting the same operation mode as that of the room with the first unit to be turned on.

⚠ CAUTION

- Normally, the operation mode in the room where the unit is first run is given priority, but the following situations are exceptions, so please keep this in mind.

If the operation mode of the first room is **FAN operation**, then using **HEAT operation** in any room after this will give priority to **HEAT operation**. In this situation, the air conditioner running in FAN operation will go on standby, and the OPERATION lamp will flash.

With the priority room setting active.

Refer to “**Priority room setting**” on the next page.

■ NIGHT QUIET mode (Available only for COOL operation)

NIGHT QUIET mode requires initial programming during installation. Please consult your retailer or dealer for assistance. NIGHT QUIET mode reduces the operation noise of the outdoor unit during the nighttime hours to prevent annoyance to neighbors.

- The NIGHT QUIET mode is activated when the temperature drops 10.8°F (6°C) or more below the highest temperature recorded that day. Therefore, when the temperature difference is less than 7.2°F (4°C), this function will not be activated.
- NIGHT QUIET mode reduces slightly the cooling efficiency of the unit.

■ OUTDOOR UNIT QUIET operation

Refer to “**OUTDOOR UNIT QUIET operation**”. ▶Page 18

With the priority room setting present but inactive or not present.

When using the OUTDOOR UNIT QUIET operation feature with the Multi system, set all indoor units to OUTDOOR UNIT QUIET operation using their remote controllers.

When clearing OUTDOOR UNIT QUIET operation, clear one of the operating indoor units using their remote controller.

However OUTDOOR UNIT QUIET operation display remains on the remote controller for other rooms.

We recommend you release all rooms using their remote controllers.

With the priority room setting active.

Refer to “**Priority room setting**” on the next page.

Note for Multi System

■ COOL / HEAT mode lock

The COOL / HEAT mode lock requires initial programming during installation. Please consult your authorized dealer for assistance. The COOL / HEAT mode lock sets the unit forcibly to either COOL or HEAT operation. This function is convenient when you wish to set all indoor units connected to the multi system to the same operation mode.

■ Priority room setting

The priority room setting requires initial programming during installation. Please consult your authorized dealer for assistance. The room designated as the priority room takes priority in the following situations.

Operation mode priority

- As the operation mode of the priority room takes precedence, the user can select a different operation mode from other rooms.

[Example]

- Room A is the priority room in the examples.
When COOL operation is selected in room A while operating the following modes in room B, C and D :

Operation mode in room B, C and D	Status of room B, C and D when the unit in room A is in COOL operation
COOL or DRY or FAN	Current operation mode maintained
HEAT	The unit enters standby mode. Operation resumes when the room A unit stops operating.
AUTO	If the unit is set to COOL operation, it continues. If the unit is set to HEAT operation, it enters standby mode. Operation resumes when the room A unit stops operating.

Priority when POWERFUL operation is used

[Example]

- Room A is the priority room in the examples.
The indoor units in rooms A, B, C and D are all operating. If the unit in room A enters POWERFUL operation, operation capacity will be concentrated in room A. In such a case, the cooling (heating) efficiency of the units in room B, C and D may be slightly reduced.

Priority when using OUTDOOR UNIT QUIET operation

[Example]

- Room A is the priority room in the examples.
Just by setting the unit in room A to QUIET operation, the air conditioner starts OUTDOOR UNIT QUIET operation. You don't have to set all the operated indoor units to QUIET operation.

Care and Cleaning

■ Quick reference

How to open / close the front panel

- Hold the front panel by the panel tabs on the both sides and open it.
- Press the front panel at both sides and the center to close it.

Cleaning parts

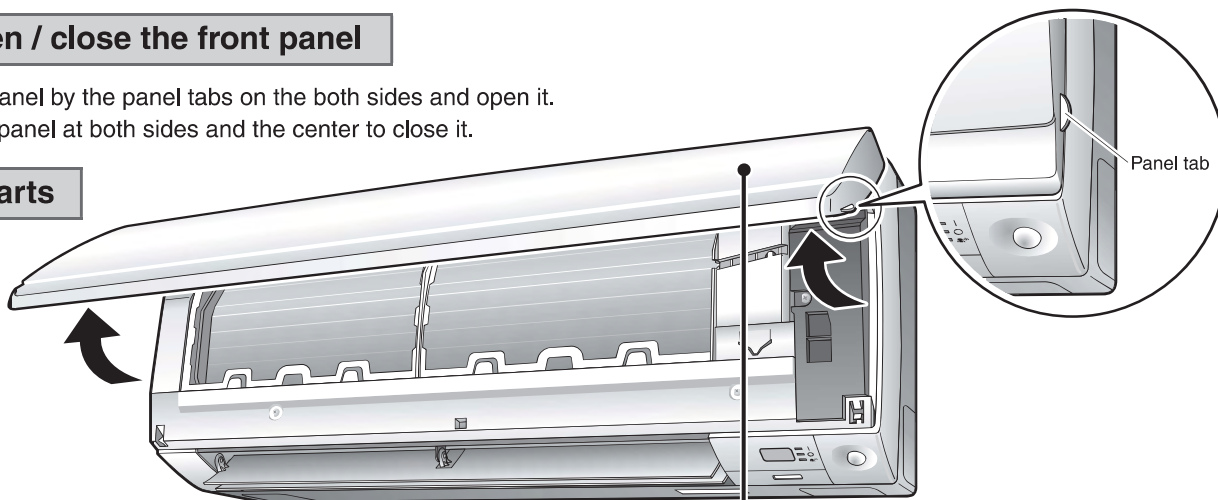

Air filter

- Vacuum dust or wash the filter.

**Once every
2 weeks**

Refer to ▶Page 32

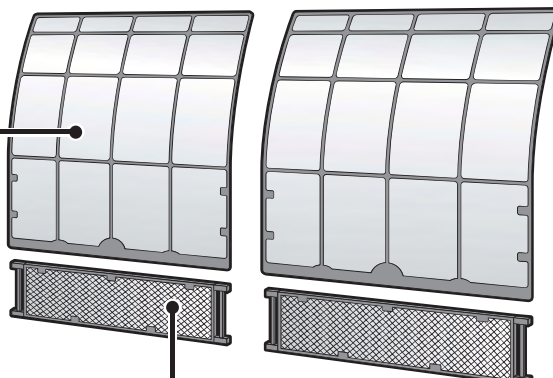

Front panel

- Wipe it with a soft damp cloth.

If bothered by dirt

Refer to ▶Page 31

Titanium apatite photocatalytic air-purifying filter

- Vacuum dust or replace the filter.

[Cleaning]

Once every 6 months

Refer to ▶Page 33

[Replacement]

Once every 3 years

Refer to ▶Page 33

Indoor unit, Outdoor unit and Remote controller

- Wipe them with a soft cloth.

If bothered by dirt

Notes on cleaning

■ For cleaning, do not use the materials as follows.

- Hot water above 104°F (40°C).
- Benzine, gasoline, thinner, other volatile oils.
- Polishing compound.
- Scrubbing brushes, other hard stuff.



⚠ CAUTION

- Before cleaning, be sure to stop the operation and turn the breaker off.
- Do not touch the aluminum fins of the indoor unit. If you touch those parts, this may cause an injury.

Care and Cleaning

■ Front panel

1. Remove the front panel.

- Open the front panel.
- Slide the front panel to either the left or right and pull it toward you. This will disconnect the front panel shaft on one side.

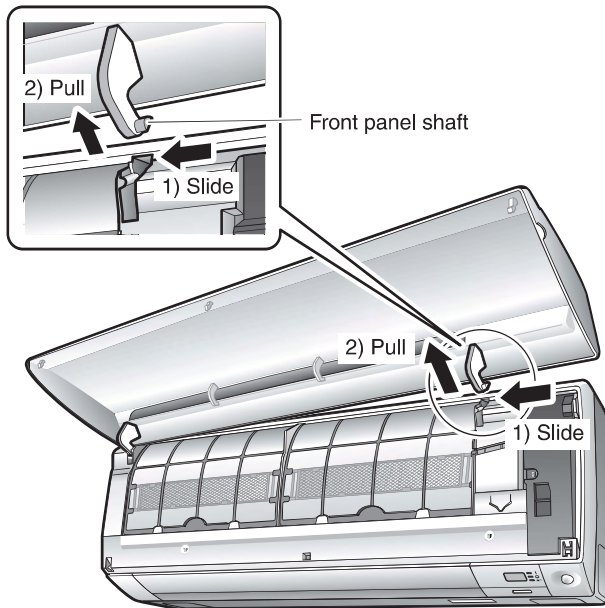

- Disconnect the front panel shaft on the other side in the same manner.

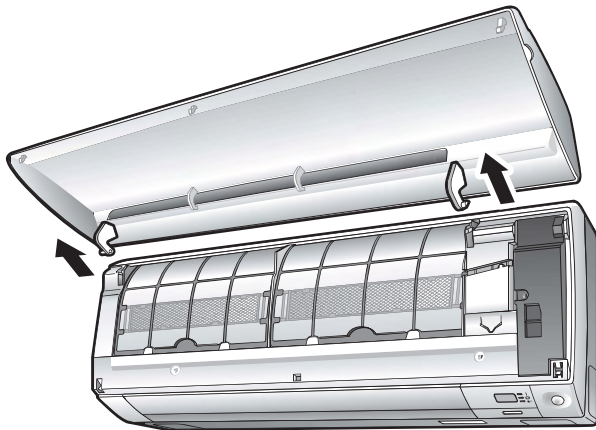

2. Clean the front panel.

- Wipe it with a soft damp cloth.
- Only neutral detergent may be used.
- In case of washing the panel with water, wipe it with a dry soft cloth, and let it dry in the shade after washing.

3. Attach the front panel.

- Align the front panel shaft on the left and right of the front panel with the slots, then push them all the way in.

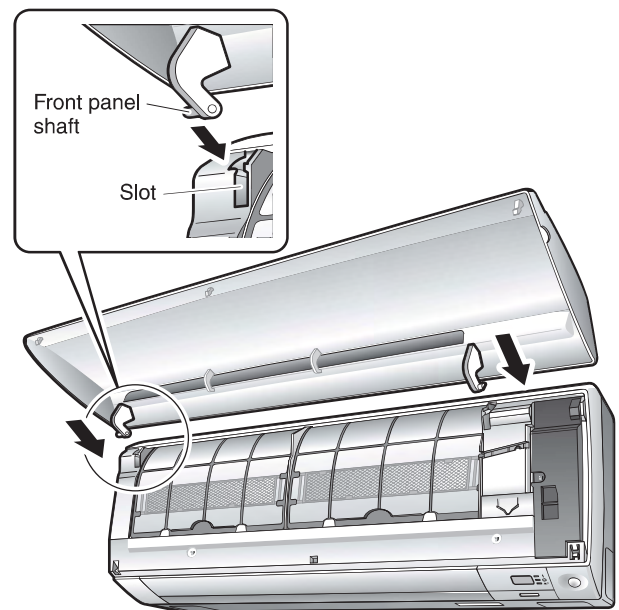

- Close the front panel slowly. (Press the panel at both sides and the central area.)

⚠ CAUTION

- When removing or attaching the front panel, stand on a solid, stable base and take care not to fall.
- When removing or attaching the front panel, support the panel securely with hand to prevent it from falling.
- After cleaning, make sure that the front panel is securely fixed.

■ Air filter

1. Pull out the air filters.

- Open the front panel.
- Push the filter tab at the center of each air filter slightly upward, then pull it down.

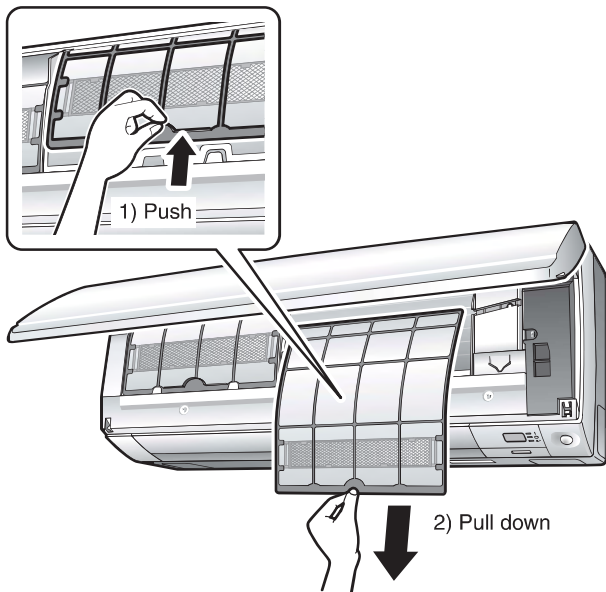

2. Wash the air filters with water or clean them with vacuum cleaner.

- It is recommended to clean the air filters every 2 weeks.



If the dust does not come off easily

- Wash the air filters with neutral detergent thinned with lukewarm water, then let them dry in the shade.
- Be sure to remove the titanium apatite photocatalytic air-purifying filter. Refer to "Titanium apatite photocatalytic air-purifying filter" on the next page.



3. Set the filters as they were and close the front panel.

- Press the front panel at both sides and the central area.

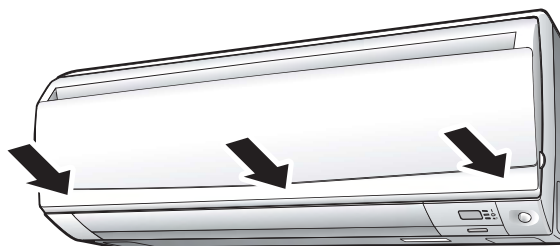

⚠ CAUTION

- Do not touch the aluminum fins by bare hand at the time of dismantling or mounting the filter.

Care and Cleaning

■ Titanium apatite photocatalytic air-purifying filter

1. Take off the titanium apatite photocatalytic air-purifying filter.

- Open the front panel and pull out the air filters.
- Hold the recessed parts of the frame and unhook the 4 claws.

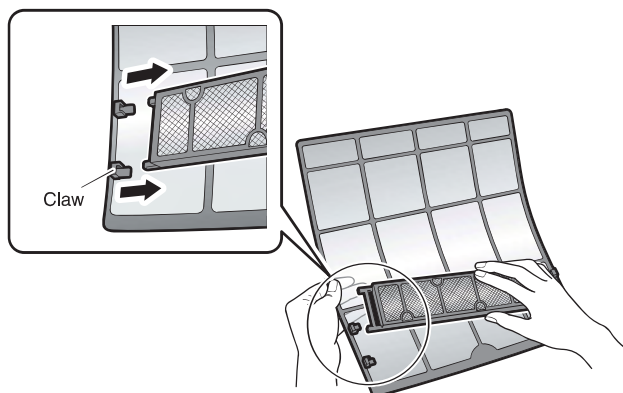

2. Clean or replace the titanium apatite photocatalytic air-purifying filter.

[Maintenance]

2-1 Vacuum dust, and soak in lukewarm water or water for about 10 to 15 minutes if dirt is heavy.

- Do not remove the filter from frame when washing with water.

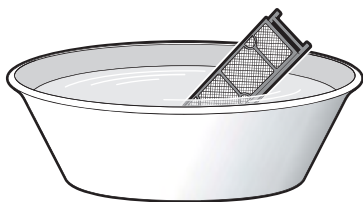

2-2 After washing, shake off remaining water and dry in the shade.

- Since the material is made out of polyester, do not wring out the filter when removing water from it.

[Replacement]

Remove the tabs on the filter frame and replace with a new filter.

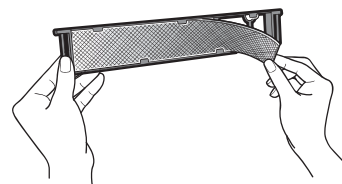

- Do not throw away the filter frame. Reuse the filter frame when replacing the titanium apatite photocatalytic air-purifying filter.
- Dispose of the old filter as non-flammable waste.

3. Set the filters as they were and close the front panel.

- Press the front panel at both sides and the central area.

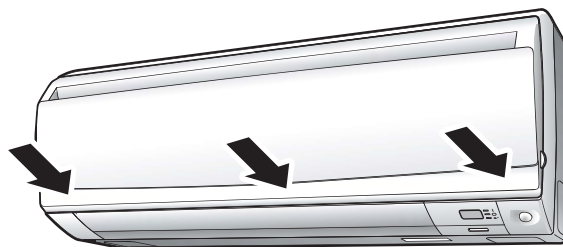

NOTE

- Operation with dirty filters:
 - cannot deodorize the air,
 - cannot clean the air,
 - results in poor heating or cooling,
 - may cause odor.
- Dispose of old filters as non-flammable waste.
- To order a titanium apatite photocatalytic air-purifying filter, contact the dealer where you bought the air conditioner.



Item	Titanium apatite photocatalytic air-purifying filter (without frame) 1 set
Part No.	KAF970A46

■ Check the units

- Check that the base, stand and other fittings of the outdoor unit are not decayed or corroded.
- Check that nothing blocks the air inlets and the outlets of the indoor unit and the outdoor unit.
- Check that the drain comes smoothly out of the drain hose during COOL or DRY operation.
 - If no drain water is seen, water may be leaking from the indoor unit. Stop operation and consult the service shop if this is the case.

■ Before a long idle period

1. Operate the FAN only for several hours on a nice day to dry out the inside.

- Press **MODE** and select “” operation.
- Press  and start the operation.

2. After operation stops, turn off the circuit breaker for the room air conditioner.

3. Clean the air filters and set them again.

4. Take out batteries from the remote controller.

- When a multi outdoor unit is connected, make sure the HEAT operation is not being used in other rooms before you use the FAN operation. [▶ Page 28](#)

■ We recommend periodical maintenance

- In certain operating conditions, the inside of the air conditioner may get foul after several seasons of use, resulting in poor performance. It is recommended to have periodical maintenance by a specialist aside from regular cleaning by the user.
- For specialist maintenance, contact the service shop where you purchased the air conditioner.
- The maintenance cost must be borne by the user.

Troubleshooting

■ These incidents are not malfunctions.

- The following incidents do not indicate a malfunctioning air conditioner and have explanations. The air conditioner can continue to operate.

Indoor unit

Possible sounds.

■ Flowing water

- Generated because the refrigerant in the air conditioner is flowing.
- This is a pumping sound of the water in the air conditioner it is heard when the water is pumped out from the air conditioner in cooling or drying operation.
- The refrigerant flows in the air conditioner even if the air conditioner is not working when the indoor units in other rooms are in operation.

■ Blowing

- Generated when the flow of the refrigerant in the air conditioner is switched over.

■ Ticking

- Generated when the size of the air conditioner slightly expands or shrinks as a result of temperature changes.

■ Whistling sound

- Generated when refrigerant flows during defrosting operation.

■ Clicking sound during operation or idle time

- Generated when the refrigerant control valves or the electrical parts operate.

■ Clopping sound

- Heard from the inside of the air conditioner when the exhaust fan is activated while the room doors are closed. Open the window or turn off the exhaust fan.



The flaps do not start swinging immediately. The flaps move soon after startup.

- The air conditioner is adjusting the position of the flaps. The flaps will start moving soon.

The HEAT operation stops suddenly and a flowing sound is heard.

- The outdoor unit is taking away the frost. The HEAT operation starts after the frost on the outdoor unit is removed. You should wait for about 4 to 12 minutes.

Operation does not start soon.

■ When "ON/OFF" button was pressed soon after operation was stopped.

■ When the mode was reselected.

- This is to protect the air conditioner. You should wait for about 3 minutes.

Outdoor unit

Operating sound is loud.

- When frost forms on the heat exchanger of the outdoor unit, the operating sound level increases slightly.

The outdoor unit emits water or steam.

■ In HEAT operation

- The frost on the outdoor unit melts into water or steam when the air conditioner is in defrost operation.

■ In COOL or DRY operation

- Moisture in the air condenses into water on the cool surface of outdoor unit piping and drips.

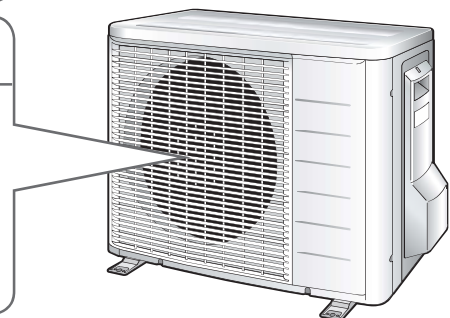

- Troubleshooting measures are classified into the following two types on a remedial basis. Take an appropriate measure according to the symptom.



Not malfunction

- The following conditions do not indicate a problem with the system.



Check

- Please check again before calling a repair person.

The air conditioner does not operate. (OPERATION lamp is off.)

- Is a breaker off or a fuse blown?
- Is there a power failure?
- Are batteries set in the remote controller?
- Is the timer setting correct?



Air does not come out.

■ In HEAT operation

- The air conditioner is warming up. Wait for about 1 to 4 minutes.
- During defrosting operation, hot air does not flow out of the indoor unit.

■ When the air conditioner operates immediately after the circuit breaker is turned on

- The air conditioner is preparing to operate. Wait for about 3 to 20 minutes.



Operation stopped suddenly. (OPERATION lamp is on.)

- For system protection, the air conditioner may stop operating on a sudden large voltage fluctuation. It automatically resumes operation in about 3 minutes.



Operation stopped suddenly. (OPERATION lamp flashes.)

- Are the air filters clean?
Clean the air filters.
- Is there anything to block the air inlet or the outlet of the indoor and the outdoor units?
- Turn the bleaker off and take all obstacles away. Then turn it on again and try operating the air conditioner with the remote controller. If the lamp still flashes, call the service shop where you purchased the air conditioner.
- Are operation modes all the same for indoor units connected to outdoor units in the **multi system**?
If not, set all indoor units to the same operation mode and confirm that the lamps flash.
When the operation mode is in "AUTO", set all indoor unit operation modes to "COOL" or "HEAT" for a moment and check again that the lamps are normal. If the lamps stop flashing after the above steps, there is no malfunction. ▶Page 28



Mist comes out of the indoor unit.

- This happens when the air in the room is cooled into mist by the cold airflow during COOL operation.
- This is because the air in the room is cooled by the heat exchanger and becomes mist during defrosting operation.



Troubleshooting

Cooling (Heating) effect is poor.

- Are the air filters clean?
- Is there anything to block the air inlet or the outlet of the indoor and the outdoor units?
- Is the temperature setting appropriate?
- Are the windows and doors closed?
- Are the airflow rate and the airflow direction set appropriately?



Remote controller does not work properly.

- No remote controller signals are displayed.
- Remote controller sensitivity is low.
- Display is low in contrast or blacked out.
- Display runs out of control.
- The batteries are dying and the remote controller is malfunctioning. Replace all the batteries with new, size AAA.LR03 (alkaline). For details, refer to "To set the batteries" of this manual. ▶Page 9



HEAT operation cannot be selected, even though the unit is heat pump model.

- Slide the DIP switch to the left as shown in the illustration so that the HEAT operation can be selected with the "MODE" button.

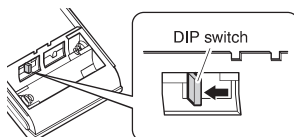

The ON/OFF TIMER does not operate according to the settings.

- Check if the ON/OFF TIMER and the WEEKLY TIMER are set to the same time. Change or deactivate the settings in the WEEKLY TIMER. ▶Page 22



The indoor unit gives out odor.

- This happens when smells of the room, furniture, or cigarettes are absorbed into the unit and discharged with the airflow. (If this happens, have the indoor unit washed by a technician from the service shop where you purchased the air conditioner.)



The outdoor fan rotates while the air conditioner is not in operation.

- After operation is stopped
 - The outdoor fan continues rotating for another 60 seconds for system protection.
- While the air conditioner is not in operation
 - When the outdoor temperature is very high, the outdoor fan starts rotating for system protection.



An abnormal functioning happens during operation.

- The air conditioner may malfunction with lightning or radio waves. Turn the breaker off, turn it on again and try operating the air conditioner with the remote controller.



■ Call the service shop immediately

WARNING

- **When an abnormality (such as a burning smell) occurs, stop operation and turn the breaker off.**
 - Continued operation in an abnormal condition may result in malfunctioning, electric shocks or fire.
 - Consult the service shop where you purchased the air conditioner.
- **Do not attempt to repair or modify the air conditioner by yourself.**
 - Incorrect work may result in electric shocks or fire.
 - Consult the service shop where you purchased the air conditioner.

If one of the following symptoms occurs, call the service shop immediately.

- The power cord is abnormally hot or damaged.
- An abnormal sound is heard during operation.
- The safety breaker, a fuse, or the ground leakage breaker cuts off the operation frequently.
- A switch or a button often fails to work properly.
- There is a burning smell.
- Water leaks from the indoor unit.

Turn the breaker off and call the service shop.



■ After a power failure

- The air conditioner automatically resumes operation in about 3 minutes. Wait for it to restart.

■ Lightning

- If lightning may strike the neighboring area, stop operation and turn the breaker off for system protection.

■ Disposal requirements

- Dismantling the unit, and treatment of refrigerant, oil, and other parts, should be done in accordance with the relevant local and national regulations.

Troubleshooting

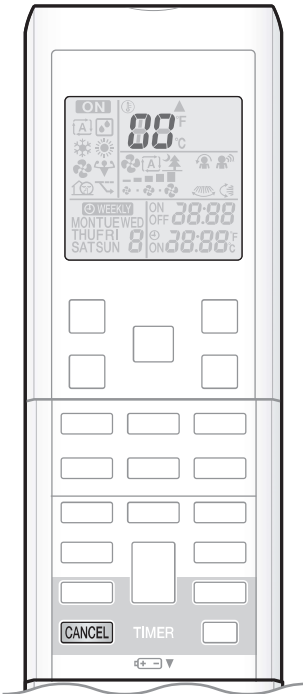

■ Fault diagnosis by remote controller

- The remote controller can receive a corresponding error code from the indoor unit.

1. When **CANCEL** is held down for about 5 seconds, “00” blinks in the temperature display section.

2. Press **CANCEL** repeatedly until a continuous beep is produced.

- The code indication changes as displayed in the following table, and notifies with a long beep.

	CODE	MEANING
SYSTEM	00	NORMAL
	UA	INDOOR-OUTDOOR UNIT COMBINATION FAULT
	U0	REFRIGERANT SHORTAGE
	U2	DROP VOLTAGE OR MAIN CIRCUIT OVERVOLTAGE
	U4	FAILURE OF TRANSMISSION (BETWEEN INDOOR UNIT AND OUTDOOR UNIT)
INDOOR UNIT	A1	INDOOR PCB DEFECTIVENESS
	A5	HIGH PRESSURE CONTROL OR FREEZE-UP PROTECTOR
	A6	FAN MOTOR FAULT
	C4	FAULTY HEAT EXCHANGER TEMPERATURE SENSOR
	C9	FAULTY SUCTION AIR TEMPERATURE SENSOR
OUTDOOR UNIT	EA	COOLING-HEATING SWITCHING ERROR
	E1	CIRCUIT BOARD FAULT
	E5	OL STARTED
	E6	FAULTY COMPRESSOR START UP
	E7	DC FAN MOTOR FAULT
	E8	OVERCURRENT INPUT
	F3	HIGH TEMPERATURE DISCHARGE PIPE CONTROL
	F6	HIGH PRESSURE CONTROL (IN COOLING)
	H0	SENSOR FAULT
	H6	OPERATION HALT DUE TO FAULTY POSITION DETECTION SENSOR
	H8	DC CURRENT SENSOR FAULT
	H9	FAULTY SUCTION AIR TEMPERATURE SENSOR
	J3	FAULTY DISCHARGE PIPE TEMPERATURE SENSOR
	J6	FAULTY HEAT EXCHANGER TEMPERATURE SENSOR
	L3	ELECTRICAL PARTS HEAT FAULT
L4	HIGH TEMPERATURE AT INVERTER CIRCUIT HEATSINK	
L5	OUTPUT OVERCURRENT	
P4	FAULTY INVERTER CIRCUIT HEATSINK TEMPERATURE SENSOR	

NOTE

- A short beep and two consecutive beeps indicate non-corresponding codes.
- To cancel the code display, hold **CANCEL** for 5 seconds. The code display also cancel itself if the button is not pressed for 1 minute.

■ MEMO

Quick Reference

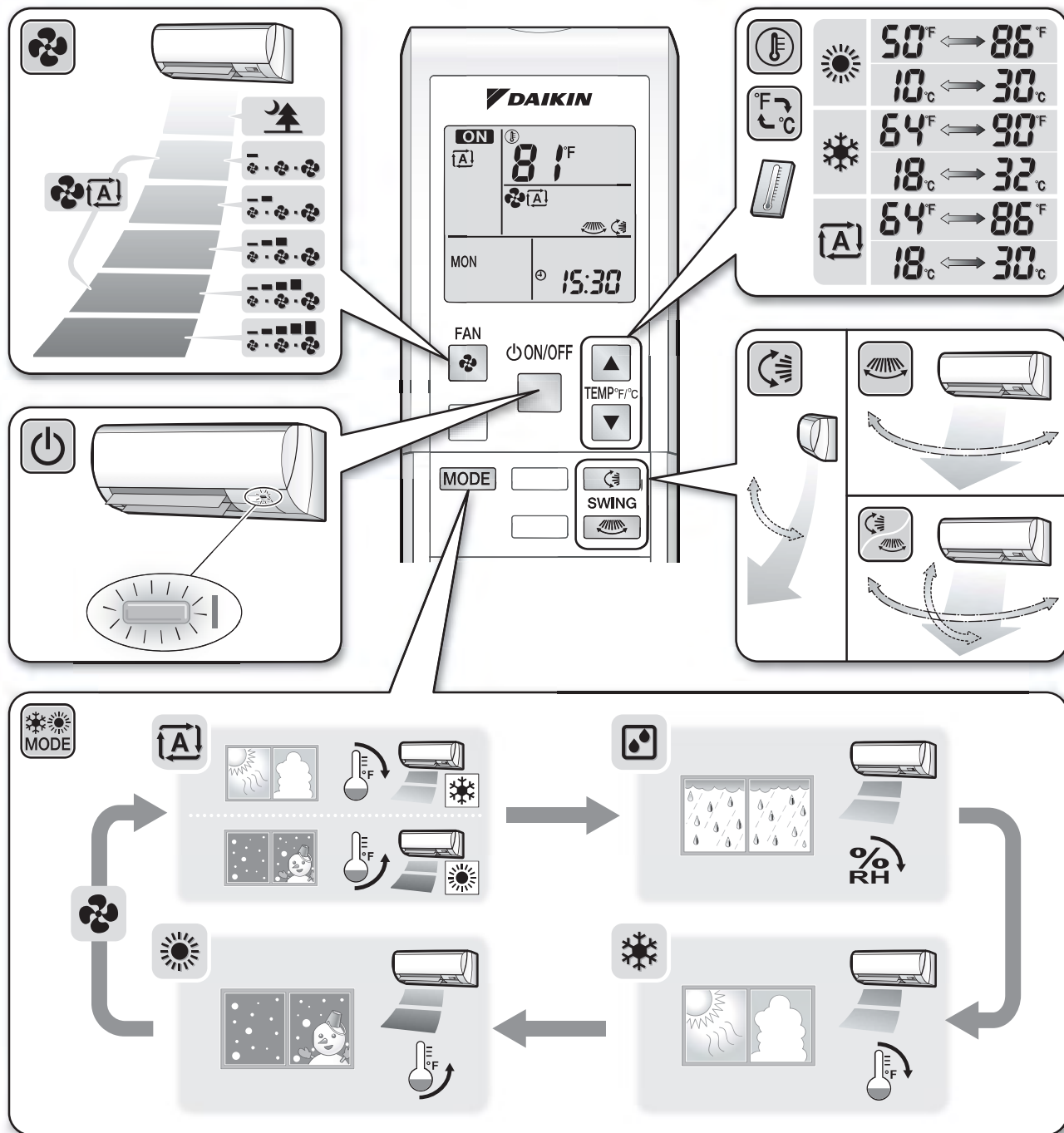

GOODMAN MANUFACTURING COMPANY, L.P.

5151 San Felipe, Suite 500
Houston, TX 77056 USA

DAIKIN INDUSTRIES, LTD.

Head office:
Umeda Center Bldg., 2-4-12, Nakazaki-Nishi,
Kita-ku, Osaka, 530-8323 Japan

Tokyo office:
JR Shinagawa East Bldg., 2-18-1, Konan,
Minato-ku, Tokyo, 108-0075 Japan
<http://www.daikin.com>



The two-dimensional bar code is a manufacturing code.

3P297290-1C | M11B116A (1511) HT