

DAIKIN ROOM AIR CONDITIONER

OPERATION MANUAL

INVERTER

English

Français



MODELS

FTXG09HVJU

FTXG12HVJU

FTXG15HVJU

Contents

READ BEFORE OPERATION

Safety Precautions.....	2
Names of Parts	4
Preparation before Operation	8

OPERATION

COOLING · “SARARA” DRYING Operation	10
HEATING Operation	11
AUTO Operation	12
FLASH STREAMER AIR PURIFYING · POWERFUL Operation.....	13
Adjusting the Airflow Direction and Rate.....	14
COMFORT AIRFLOW · COOLING BREEZE Operation.....	15
TIMER Operation.....	16
COMFORT SLEEP Operation	17
SET UP · CHILD PROOF LOCK	18
INFORMATION DISPLAY	19

CARE

Care and Cleaning.....	20
------------------------	----

TROUBLE SHOOTING

Troubleshooting	29
-----------------------	----





Safety Precautions

- Read these safety considerations for operations carefully before installing air conditioning equipment. After completing the installation, make sure that the unit operates properly during the startup operation. Instruct the customer on how to operate and maintain the unit.

Inform customers that they should store this operation manual with the installation manual for future reference.

Meanings of DANGER, WARNING, CAUTION, and NOTE Symbols:



 DANGER	 WARNING	 CAUTION
Indicates an imminently hazardous situation which, if not avoided, will result in death or serious injury.	Indicates a potentially hazardous situation which, if not avoided, could result in death or serious injury.	Indicates a potentially hazardous situation which, if not avoided, may result in minor or moderate injury. It may also be used to alert against unsafe practices.

 Never do.	 Be sure to follow the instructions.
 Be sure to ground the air conditioner.	
 Never touch the air conditioner (including the remote controller) with a wet hand.	 Never allow the air conditioner or remote controller to get wet.



DANGER

- For refrigerant leakage, consult your dealer.
Refrigerant gas is heavier than air and replaces oxygen. A massive leak could lead to oxygen depletion, especially in basements, and an asphyxiation hazard could occur leading to serious injury or death.
- Refrigerant gas may produce a toxic gas if it comes in contact with fire such as from a fan heater, stove or cooking device. Exposure to this gas could cause severe injury or death.
- Any abnormalities in the operation of the air conditioner such as smoke or fire could result in severe injury or death.
Turn off the power and contact your dealer immediately for instructions.
- Do not install the unit in an area where flammable materials are present due to risk of explosion resulting in serious injury or death.
- If equipment utilizing a burner is used in the same room as the air conditioner, there is the danger of oxygen deficiency which could lead to an asphyxiation hazard resulting in serious injury or death.
Be sure to ventilate the room sufficiently to avoid this hazard.
- Safely dispose of the packing materials.
Packing materials, such as nails and other metal or wooden parts, may cause stabs or other injuries. Tear apart and throw away plastic packaging bags so that children will not play with them. Children playing with plastic bags face the danger of death by suffocation.





WARNING

-  It is not good for health to expose your body to the air flow for a long time.
- Do not put your finger or other objects into the air outlet or inlet as the fan is rotating at high speed and could cause injury. Always keep small children away from the unit during operation.
- Do not attempt to repair, relocate, modify or reinstall the air conditioner by yourself. Incorrect work or modifications could cause electric shocks, fire or other damage.
For repairs and reinstallation, consult your Daikin dealer for advice and information.
-  If the air conditioner is not cooling (heating) properly, the refrigerant may be leaking, contact your authorized dealer or qualified service repairman.
When making repairs which requires adding refrigerant, consult with your authorized dealer or qualified service repairman.
- Do not attempt to install the air conditioner by yourself. Improper installation could result in water leakage, electric shocks or fire. For installation, consult your authorized dealer or a qualified technician.

CAUTION

-  The air conditioner must be grounded. Improper grounding may result in electric shocks. Do not connect the grounding wire to a gas pipe, water pipe, lightning rod, or a telephone ground line. Follow all local and state electrical codes.
-  Do not use this unit for cooling precision instruments, food, plants, animals or works of art.
- Never expose little children, plants or animals directly to the air flow.
- Do not block air inlets nor outlets. Impaired air flow may result in poor performance or equipment problems.
- Do not stand, sit, or place objects on the outdoor unit. To avoid injury, do not remove the fan guard.

CAUTION

-  • Do not place anything under the indoor or outdoor unit that must be kept away from moisture, such as electrical or electronic equipment. In certain conditions, moisture in the air may condense and drip.
 - Check the unit stand and fittings for damage annually.
 - Do not touch the air inlet and aluminum fins of outdoor unit. It may cause injury and/or damage the heat transfer surface.
 - This appliance is NOT intended for use by young children or impaired persons without proper supervision.
 - Young children should be supervised to ensure that they DO NOT play with or near the air flow of this appliance.
 - Do not pull at the conduit or hang anything on it. Otherwise it will cause fire or electric shock.
 - Do not touch the heat exchanger fins. Improper handling may result in injury.
 - Do not turn off the power immediately after stopping operation. Always wait at least 5 minutes before turning off the power to avoid water leakage or other problems.
-
-  • To avoid personal injury or equipment damage be sure to stop the operation, turn the breaker off or pull out the supply cord before cleaning or servicing the unit. NOTE: More than one disconnect may be required to shut off all power.
 - Do not connect the air conditioner to a power supply different from the one specified. It may cause improper operation or fire.
 - Depending on the environment, state and local electrical codes, a ground fault circuit interrupter may be required. Improper grounding or lack of a ground fault circuit interrupter may result in electrical shock, injuries, or death.
 - It is recommended to install a ground fault circuit interrupter if one is not already available.
This helps prevent electrical shocks or fire.
 - Arrange the drain hose to ensure smooth drainage. Improper drainage may cause water damage to the building, or its furnishing.
 - Depending on the usage environment, water may leak from the air conditioner. If this happens, contact your Daikin Dealer.
 - The remote controller should be installed in such away that children cannot play with it.
 - Do not place objects in direct proximity of the outdoor unit and do not let leaves and other debris accumulate around the unit. Leaves are a hotbed for small animals which can enter the unit. Once in the unit, such animals can cause malfunctions, smoke or fire when making contact with electrical parts.
-
-  • Do not operate the air conditioner with wet hands.
-
-  • Do not wash the indoor unit with excessive water, only use a slightly wet cloth.
 - Do not place things such as vessels containing water or anything else on top of the unit. Water may penetrate into the unit and degrade electrical insulations, resulting in an electric shock.

Installation site.

- Operate the air conditioner in a sufficiently ventilated area and not surrounded by obstacles. Do not use the air conditioner in the following places.
 - a. Places with a mist of mineral oil, such as cutting oil.
 - b. Locations such as coastal areas where there is a lot of salt in the air.
 - c. Locations such as hot springs where there is a lot of sulfur in the air.
 - d. Locations such as factories where the power voltage varies a lot.
 - e. In cars, boats, and other vehicles.
 - f. Locations such as kitchens where oil may splatter or where there is steam in the air.
 - g. Locations where equipment produces electromagnetic waves.
 - h. Places with an acid or alkaline mist.
 - i. Places where fallen leaves can accumulate or where weeds can grow.

Consider the nuisance of noise to your neighbors.

- Pay Attention to Operating Sound. Be sure to use the following places:
 - a. Places that can sufficiently withstand the weight of the air conditioner yet can suppress the operating sound and vibration of the air conditioner.
 - b. Places where warm air from the air outlet of the outside unit or the operating sound of the outside unit does not annoy neighbors.
Make sure that there are no obstacles close to the outside unit. Obstacles close to the outside unit may drop the performance of the outside unit or increase the operating sound of the outside unit.
Consult your dealer if the air conditioner in operation generates unusual noise.

Electrical work.

- For power supply, be sure to use a separate power circuit dedicated to the air conditioner.

System relocation.

- Relocating the air conditioner requires specialized knowledge and skills. Please consult the dealer if relocation is necessary for moving or remodeling.

Names of Parts

Indoor Unit

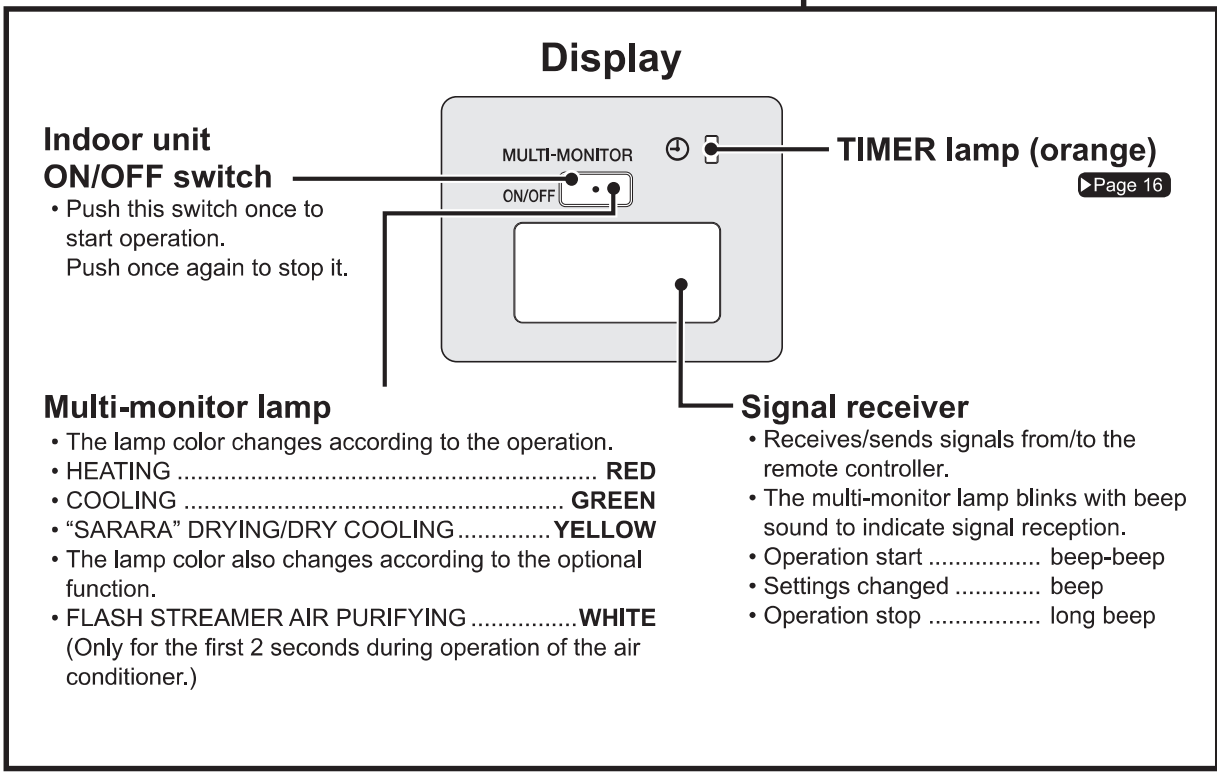
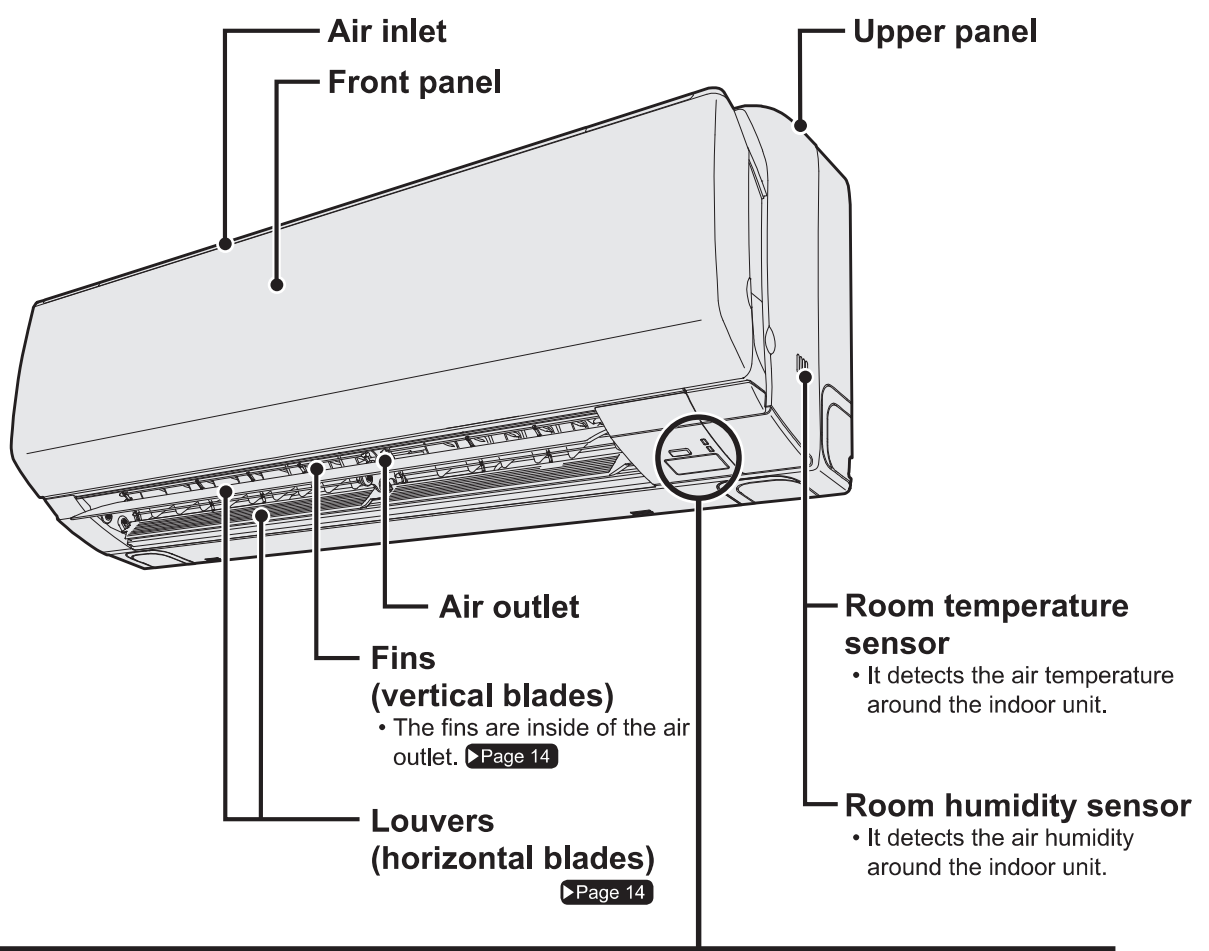

Open the front panel

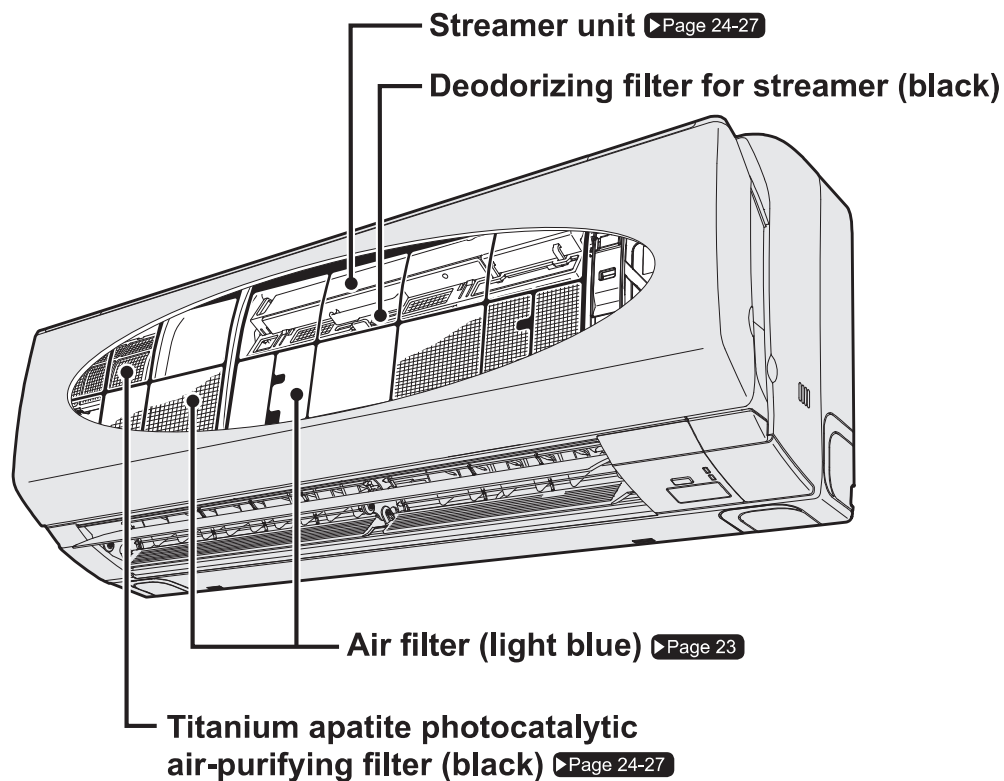

Outdoor Unit

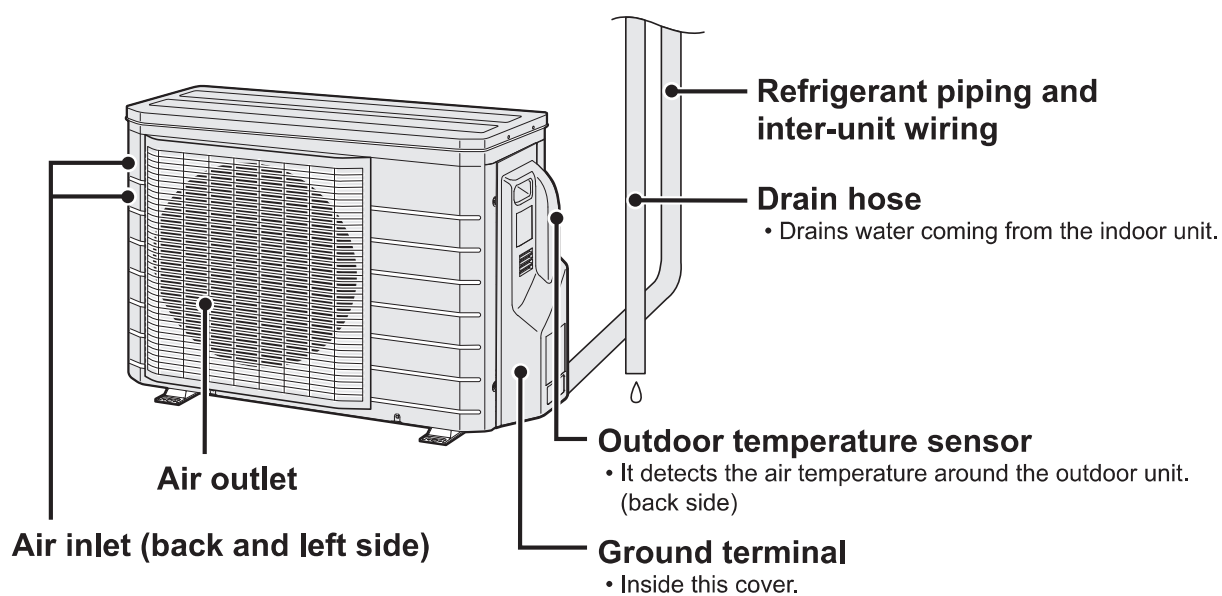

Names of Parts

Remote Controller: ARC447A3

Transmitter/Receiver

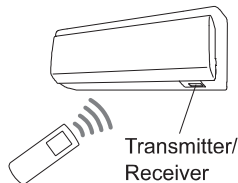

- To use the remote controller, aim the transmitter at the indoor unit. If there is anything to block signals between the unit and the remote controller, such as a curtain, the unit will not operate.
- Do not drop the remote controller. Do not get it wet.
- The maximum distance for communication is approximately 23ft (7m).

COUNTDOWN OFF TIMER button

- Sets time to stop. ▶Page 16

INFORMATION button

- Displays the indoor temperature and humidity and the outdoor temperature. ▶Page 19

TEMPERATURE adjustment buttons

- Changes the temperature setting.

POWERFUL button

- Makes cooling or heating more powerful. (Canceled in 20 minutes.) ▶Page 13

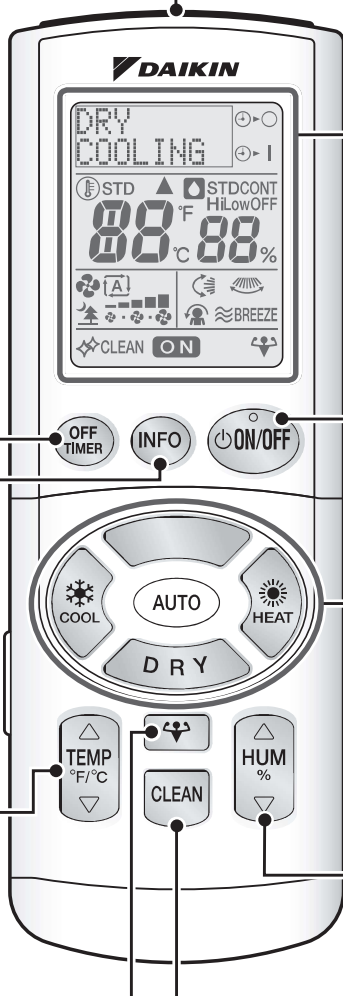

DISPLAY (LCD)

- Displays the current settings. (In this illustration, each section is shown with all its displays on for the purpose of explanation.)
- * The protection sheet is on the display to protect against scratch. Remove it before use.

ON/OFF button

- Stops operation selected with the direct operation button. Another press will restart the same operation.

DIRECT operation button

- AUTO button ▶Page 12
- HEATING button ▶Page 11
- "SARARA" DRYING button ▶Page 10
- COOLING button ▶Page 10

HUMIDITY buttons

- Changes the humidity setting.

FLASH STREAMER AIR PURIFYING button

- Cleans the room air. ▶Page 13

Open the front cover

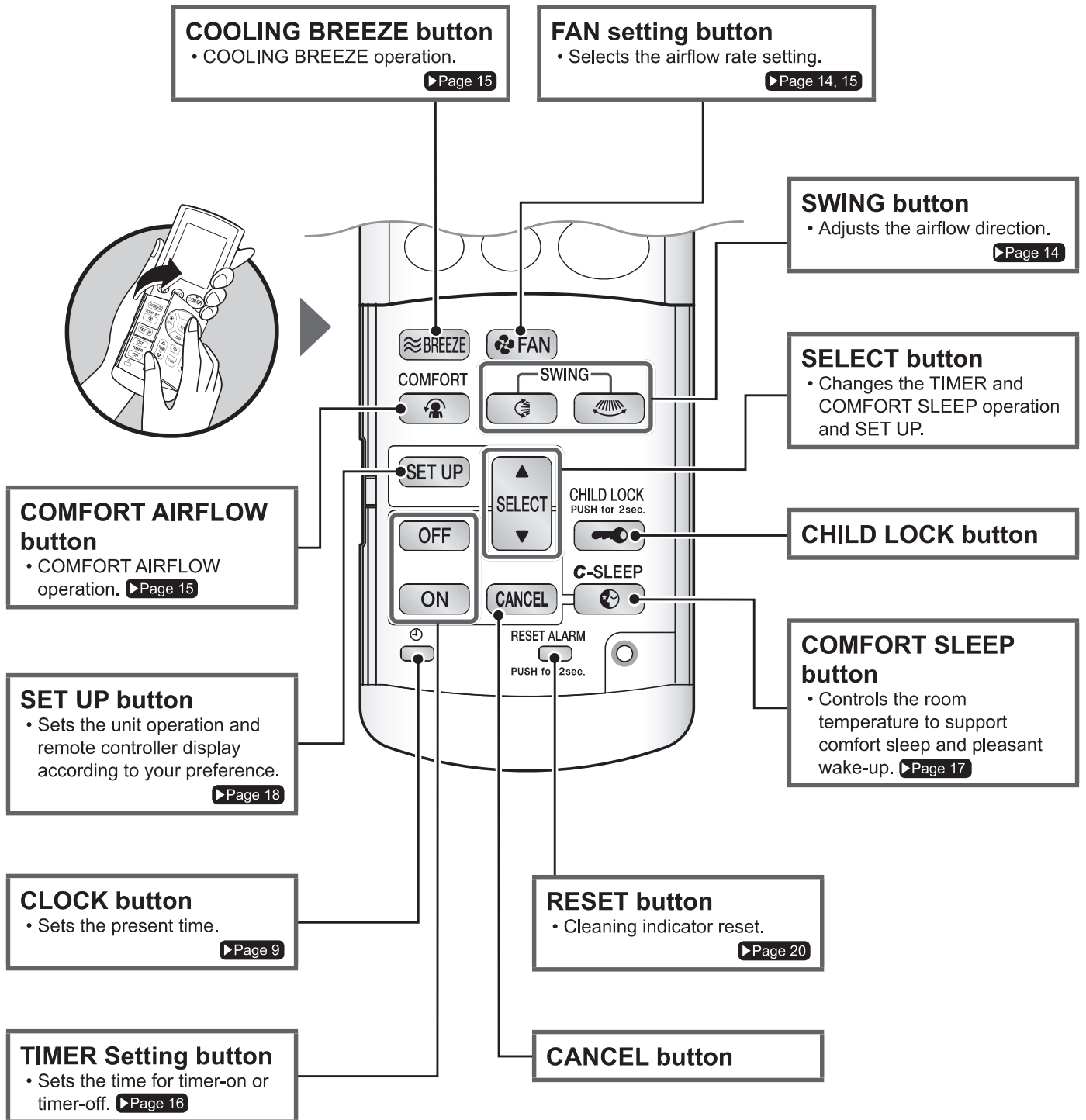

Preparation before Operation

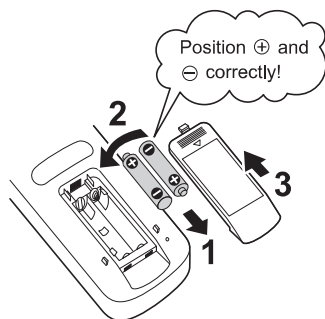

■ To set the batteries

1. Press with a finger and slide the cover to take it off.
2. Set 2 dry batteries AAA.LR03 (alkaline).
3. Set the cover as before.
 - Characters on the display will blink. Set the present time. ▶Page 9
4. Change the temperature display. See SET UP. ▶Page 18

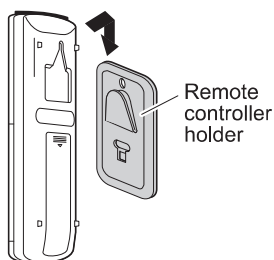

■ To fix the remote controller holder on the wall

1. Choose a place from where the signals reach the unit.
2. Fix the holder to a wall, a pillar, etc. with the screws supplied with the holder.
3. Hook the holes on back of the remote controller to the protruding tabs on the remote controller holder.

■ Attach the Titanium apatite photocatalytic air-purifying filter, deodorizing filter for streamer ▶Page 25

■ Turn on the power breaker

- After the power is turned on, the louvers of the indoor unit open and close once to set the reference position.

CAUTION

- During operation (i.e. when the panel is open or being opened or closed), do not touch the panel with your hands.

ATTENTION

- Wrap the terminals with tape to insulate them before discarding batteries. Mixing with other metals or batteries may cause heat, explosion or fire.

NOTE

■ Notes on batteries

- When replacing the batteries, use batteries of the same type, and replace both batteries at the same time.
- When the system is not used for a long time, take the batteries out.
- The batteries will last for approximately 1 year. If the remote controller display begins to fade and the degradation of reception performance occurs within a year, however, replace both batteries with new size AAA.LR03 (alkaline).
- The attached batteries are provided for the initial use of the system.
The usable period of the batteries may be short depending on the manufactured date of the air conditioner.

■ Notes on remote controller

- Never expose the remote controller to direct sunlight.
- Dust on the signal transmitter or receiver will reduce the sensitivity. Wipe off dust with a soft cloth.
- Signal communication may be disabled if an electronic-starter-type fluorescent lamp (such as inverter-type lamps) is in the room. Consult the service shop if that is the case.
- If the remote controller signals happen to operate another appliance, move that appliance to somewhere else, or consult the service shop.

■ Celsius/Fahrenheit display change function of remote controller

- The set temperature may increase when the display is changed to Celsius from Fahrenheit, because a fraction of 0.5°C is rounded up.
Example: A set temperature of 65°F (equivalent to 18.5°C) will be converted into 19°C.
When the display is changed to Fahrenheit again, the set temperature will be converted into 66°F (equivalent to 19°C) instead of the original set temperature (65°F) but a set temperature of 66°F (equivalent to 19°C) will be converted into 19°C with no temperature change.
- A reception sound will go off for the transmission of set temperature to the indoor unit at the time of setting the Celsius/Fahrenheit display change function.

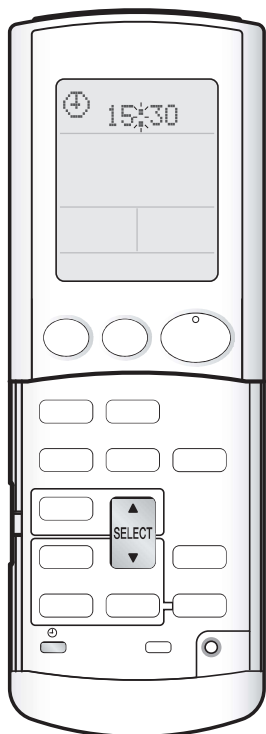

■ To set the clock

* Time cannot be set during unit operation.

1. Press .

Do not hold the button.

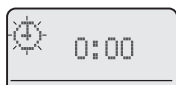

0:00 is displayed.

 blinks.

2. Press .

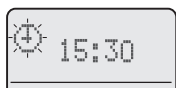

• Holding the button changes the time faster.

3. Press .

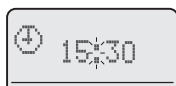

: blinks.

 is displayed.

• Setting is complete.

NOTE

If other messages than time appear on the display with the step **1** operation, do not operate the button for about 60 seconds. The display will return to normal.

■ Tips for saving energy

- Be careful not to cool (heat) the room too much.
Keeping the temperature setting at a moderate level helps save energy.
- Cover windows with a blind or a curtain.
Blocking sunlight and air from outdoors increases the cooling (heating) effect.
- Clogged air filters cause inefficient operation and waste energy.
Periodically clean the filter.

Recommended temperature setting

For cooling : 79°F – 82°F (26°C – 28°C)
For heating : 68°F – 72°F (20°C – 22°C)

■ Notes on the operating conditions

- The air conditioner always consumes a small amount of electricity even while it is not operating.
- If you are not going to use the air conditioner for a long period, for example in spring or autumn, turn the breaker off.
- When the outdoor temperature is below 5°F (–15°C), turn on the breaker more than 1 hour before starting the operation.
(This is to warm up the compressor.)
- Running the unit under conditions not listed below may cause the safety device to activate, stopping the unit. Also, condensation may form on the indoor unit and drip. (DRY/COOLING operation)

MODE	Operating conditions
COOLING	Outdoor temperature : 14 to 109°F (–10 to 43°C) Indoor temperature : 64 to 90°F (18 to 32°C) Indoor humidity : 80% max.
HEATING	Outdoor temperature : –4 to 75°F (–20 to 24°C) Indoor temperature : 50 to 86°F (10 to 30°C) Indoor humidity : 70% max.
DRY	Outdoor temperature : 50 to 108°F (10 to 42°C) Indoor temperature : 64 to 86°F (18 to 30°C) Indoor humidity : 80% max.

COOLING · “SARARA” DRYING Operation

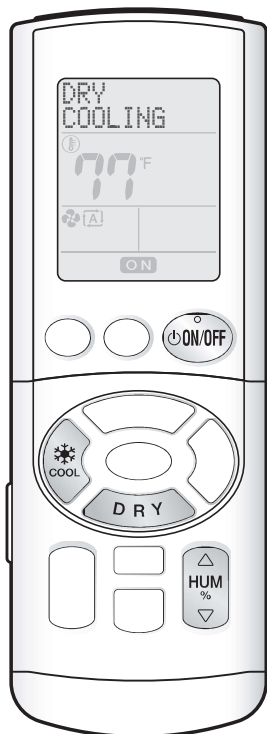

COOLING operation

To lower temperature



- The multi-monitor lamp of the unit will turn on **GREEN**.

To lower temperature and humidity



- The multi-monitor lamp of the unit will turn on **YELLOW**.
- * It is recommended to switch to COOLING operation if you want to lower temperature preferentially during DRY COOLING operation.

“SARARA” DRYING operation

To lower humidity





- The multi-monitor lamp of the unit will turn on **YELLOW**.

■ To stop operation



- The multi-monitor lamp of the unit will go off.

■ To change the temperature or humidity setting

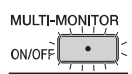
	COOLING	DRY COOLING	DRY
	64°F – 90°F (18°C – 32°C)		-5°F (-3°C) – STD
	OFF ⇄ HIGH ⇄ STD ⇄ LOW ⇄ CONT		HIGH ⇄ STD ⇄ LOW ⇄ CONT
	GREEN	YELLOW	

NOTE

■ Note on ON/OFF button

- Pressing  will start the same operation as the last time.

■ Note on COOLING operation

- This air conditioner cools the room by blowing the hot air in the room outside, so if the outside temperature is high, performance drops.

■ Notes on DRY COOLING

- Pressing the humidity button down in COOLING operation set the unit to DRY COOLING.
- Removes more humidity than the normal COOLING operation. It is recommended, however, to set temperature slightly lower than the room temperature to lower humidity because this operation mode does not heat air supplementary.

■ Notes on “SARARA” DRYING operation

- Removes humidity with less lowering of the room temperature by heating air supplementary.
- The operation mode change from COOLING to “SARARA” DRYING may raise humidity temporarily.

HEATING Operation

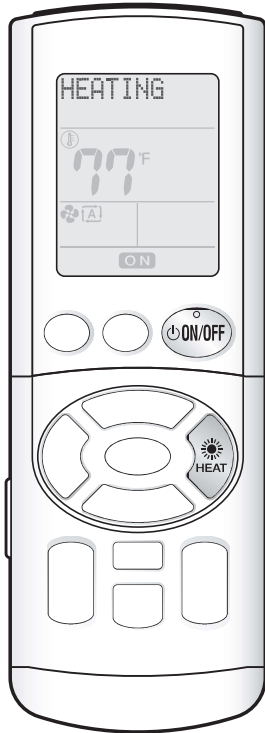

HEATING operation

To raise temperature

Press  .



- The multi-monitor lamp of the unit will turn on **RED**.

To stop operation

Press  .

- The multi-monitor lamp of the unit will go off.

To change the temperature

	HEATING
	50°F – 86°F (10°C – 30°C)
MULTI-MONITOR ON/OFF 	RED

NOTE

Notes on HEATING operation

- Since this air conditioner heats the room by taking heat from outdoor air to indoors, the heating capacity becomes smaller in lower outdoor temperatures. If the heating effect is insufficient, it is recommended to use another heating appliance in combination with the air conditioner.
- The heat pump system heats the room by circulating hot air around all parts of the room. After the start of HEATING operation, it takes some time before the room gets warmer.
- In HEATING operation, frost may occur on the outdoor unit and lower the heating capacity. In that case, the system switches into defrost operation to take away the frost.
- During defrost operation, hot air does not flow out of indoor unit.

AUTO Operation

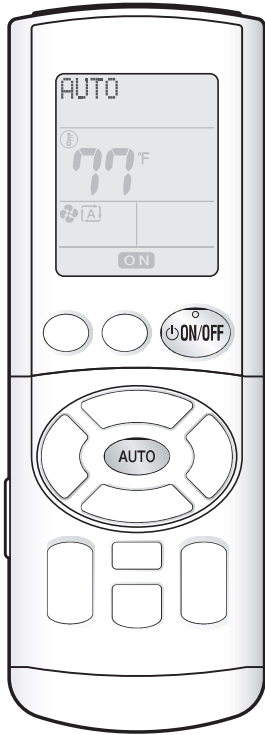

After pressing the AUTO button, the air conditioner will operate according to room conditions in an automatic mode.

Press  .

- **HEATING:** The multi-monitor lamp of the unit will turn on **RED**.
- **COOLING:** The multi-monitor lamp of the unit will turn on **GREEN**.
- The color of the multi-monitor lamp changes according to the actual operations.
- When the AUTO button is pressed, the color according to the operation selected by the air conditioner will light up.

■ To change the temperature setting

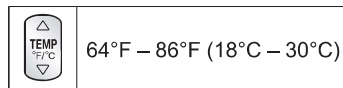

■ To stop operation

Press  .

- The multi-monitor lamp of the unit will go off.

NOTE

■ Notes on AUTO operation

- In AUTO operation, the system selects an appropriate operation mode (COOLING or HEATING) based on the room temperature at the start of the operation.
- The system automatically reselects setting at a regular interval to bring the room temperature to user-setting level.
- If you do not like AUTO operation, you can manually select the operation mode and setting you like.

FLASH STREAMER AIR PURIFYING · POWERFUL Operation



The absorption power of the Titanium apatite photocatalytic air-purifying filter and air supply filter and the resolving power of the streamer discharge reduce bad odors and viruses, cleaning the room air.

Press .

(Can be used together with heating or cooling, or on its own.)

- Changes every time the button is pressed. (Use instead of FAN operation.)



- The multi-monitor lamp of the unit will turn on **WHITE**.
(This will illuminate whitely for the first 2 seconds of operation of the air conditioner.)

POWERFUL operation quickly maximizes the cooling (heating) effect in any operation mode.

Press  during operation.

- POWERFUL operation ends in 20 minutes.



- **POWERFUL COOLING**: The multi-monitor lamp of the unit will turn on **GREEN**.

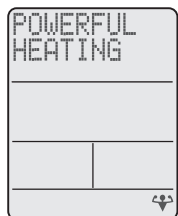

- **POWERFUL HEATING**: The multi-monitor lamp of the unit will turn on **RED**.

■ To cancel POWERFUL operation

Press  again.

- The operation mode goes back to the previous one. The multi-monitor lamp on the unit also goes back to the previous color.

NOTE

■ Notes on FLASH STREAMER AIR PURIFYING operation



- The streamer discharge energy and Titanium apatite photocatalytic air-purifying filter clean the air in the room.
- Temperature and humidity cannot be changed during FLASH STREAMER AIR PURIFYING operation only.

■ What is streamer discharge?

- It generates high-speed electron with high oxidizing power in the unit to resolve odor and harmful gas.
(It is safe because the high-speed electron is generated and goes away inside the unit.)

* The streamer discharge fizzes, but this is not a malfunction.

■ Notes on POWERFUL operation

- Can be used for COOLING, DRY COOLING and HEATING. (Cannot be used while the unit is not running.)
Pressing  during COOLING, DRY COOLING changes the operation mode to POWERFUL COOLING.
Pressing  during HEATING, change the operation mode to POWERFUL HEATING.
- The operation noise is slightly louder during POWERFUL operation.

Adjusting the Airflow Direction and Rate

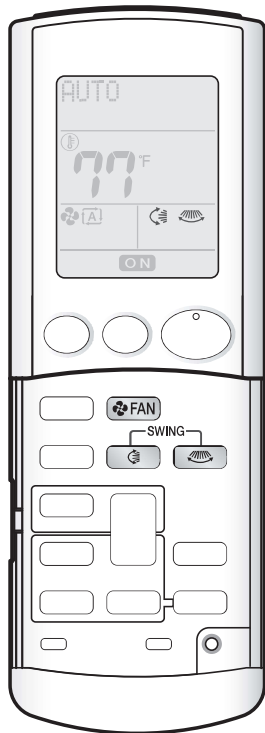

More comfortable airflow is provided with airflow direction and airflow rate adjustment.

- **To change vertical and horizontal airflow directions**
Press  or  during operation.

 (In case of vertical direction) • The airflow direction indication will display.

- The louvers and fins respectively move vertically and horizontally automatically.



- **If you want to fix airflow direction**
Press  or  again.





- **To use 3-D airflow**
Press  and then  during operation.

- The vertical and horizontal airflow direction indications will display.
- The louvers and fins move alternately.

- **To cancel 3-D airflow**
Press  or  again.

- **To change the airflow rate**
Press  during operation. (Refer to table.)

- COOLING or HEATING with “” or other weak airflow rate may not cool or heat the room sufficiently.
- When the airflow is set to “”, indoor unit quiet operation will start and the noise from the unit will become quieter.

Operating mode	Airflow rate setting
“SARARA” DRYING	
DRY COOLING	
AUTO/COOLING	
HEATING	
FLASH STREAMER AIR PURIFYING	

5 levels of airflow rate settings from “” to “” plus “” “” are available.

NOTE

- If the unit is operated with the louvers pointed down and stopped in COOLING, “SARARA” DRYING, or DRY COOLING operation, the louvers will move automatically after about one hour. (This is to prevent condensation from forming on them.)

■ Note on the angles of the louvers

- The louvers swinging range depends on the operation. (See the figure.)

■ Note on 3-D airflow

- Using 3-D airflow circulates cold air, which tends to be collected at the bottom of the room, and hot air, which tends to be collected near the ceiling, throughout the room, preventing areas of cold and hot from developing.

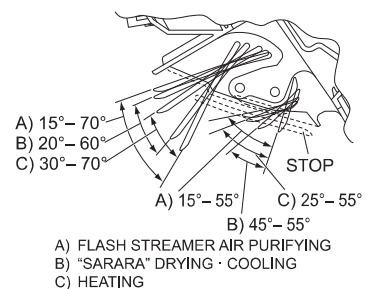

⚠ CAUTION

- Always use a remote controller to adjust the angles of the louvers and fins. If you attempt to move the louvers and fins forcibly with hand when they are swinging, the mechanism may be broken.
- Always use a remote controller to adjust the fins angles. Inside the air outlet, a fan is rotating at a high speed.

COMFORT AIRFLOW · COOLING BREEZE Operation

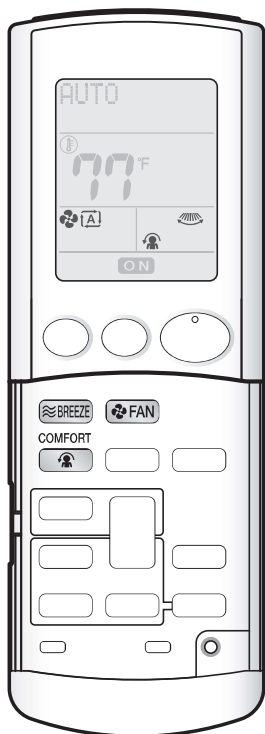

■ COMFORT AIRFLOW operation

Press .

■ COMFORT AIRFLOW operation

- The airflow direction and airflow rate are adjusted so that the air from the unit does not blow directly on the occupants of the room.
- < COOLING/DRYING > The louvers will go up.
- < HEATING > The louvers will go down.
- The airflow rate is set to "AUTO".

■ COOLING BREEZE operation

Press .

■ COOLING BREEZE operation

- COOLING BREEZE operation is for COOLING, "SARARA" DRYING and FLASH STREAMER AIR PURIFYING operation.

■ To change the airflow rate

Press during operation. (Refer to table.)

- COOLING or HEATING with "▲" or other weak airflow rate may not cool or heat the room sufficiently.
- Indoor unit quiet operation
When the airflow is set to "▲", the noise from the indoor unit will become quieter.

Operating mode	Airflow rate setting		
"SARARA" DRYING		●	●
DRY COOLING		●	●
AUTO/COOLING		●	●
HEATING		●	
FLASH STREAMER AIR PURIFYING			●

: COMFORT AIRFLOW operation is possible.

: COOLING BREEZE operation is possible.

5 levels of airflow rate settings from to plus "" " are available.

NOTE

■ Note on COMFORT AIRFLOW operation

- The airflow direction is as figure.

■ Note on COOLING BREEZE operation

- The vertical movement of the louvers with "1/ f breeze" rhythm provides comfort air like natural breeze.
The room temperature is felt cooler with cooling breeze.

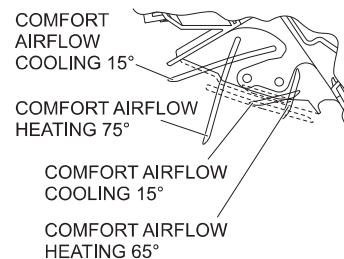

TIMER Operation

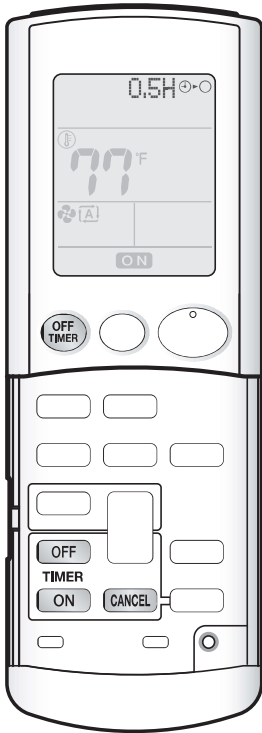

Timer functions are useful for automatically switching the air conditioner on or off at night or in the morning.

The timer operates only one time. Set the timer for each use.

■ COUNTDOWN OFF TIMER operation

Set the time to stop.

Press **OFF TIMER**.

- The displayed time, which changes in 0.5 hour increments every time the button is pressed, is set. The time from 0.5 to 9.5 hours can be set.
- TIMER lamp will light up orange.

■ ON/OFF TIMER operation

Set time for ON TIMER or OFF TIMER.

- Check that the clock is correct. If not, set the clock to the present time. ▶Page 9
- The present time display disappears when the time ON/OFF TIMER is reserved.

1. Press **OFF for OFF TIMER and press **ON** for ON TIMER.**



* OFF TIMER

2. Press **SELECT to set the time to be reserved.**

- Pressing the button changes the time in 10 minutes. Holding the button makes the time change faster.

3. Press **OFF for OFF TIMER and press **ON** for ON TIMER.**



* OFF TIMER

■ To cancel TIMER operation

Press **CANCEL**.

- The TIMER lamp will go off and the TIMER will be canceled.

NOTE

■ In the following cases, set the timer again.

- After a breaker has turned off.
- After a power failure.
- After replacing batteries in the remote controller.

■ Notes on TIMER operation

- Starting COUNTDOWN OFF TIMER and OFF TIMER causes the unit to automatically change the set temperature 1 hour later to prevent the room from becoming too cold or too hot. (Turns up 1°F (0.5°C) during COOLING or DRY COOLING and turns down 3.6°F (2°C) during HEATING.)
- Reserving the ON TIMER will cause the unit to start running up to 1 hour before, in order to make sure the temperature reaches the temperature set on the remote controller by the set time.
- When operating the unit via the COUNTDOWN OFF TIMER or OFF TIMER, the actual length of operation may vary from the time entered by the user.
- Once you set ON/OFF TIMER, the time setting is kept in the memory. However, the COUNTDOWN OFF TIMER does not have this memory function.
(The memory is canceled when remote controller batteries are replaced.)
- Cannot operate with POWERFUL or COMFORT SLEEP operation.

■ To combine ON TIMER and OFF TIMER

- See the example for reserving in combination of COUNTDOWN OFF TIMER and ON TIMER as well as OFF TIMER and ON TIMER.

■ To cancel combined reservation

- Press **ON** and then **CANCEL** to cancel the ON TIMER only.
- Press **OFF** and then **CANCEL** to cancel the OFF TIMER only.
- Press **OFF TIMER** several times to reach 9.5 hours and then press it one more time to cancel the COUNTDOWN OFF TIMER only.

(Example)

Present time: 23:00 (air conditioner is running).
You want to have the unit run for 1 more hour and then turn back on at 7:00.



Setting the OFF TIMER to 0:00
Setting the ON TIMER to 14:00



COMFORT SLEEP Operation

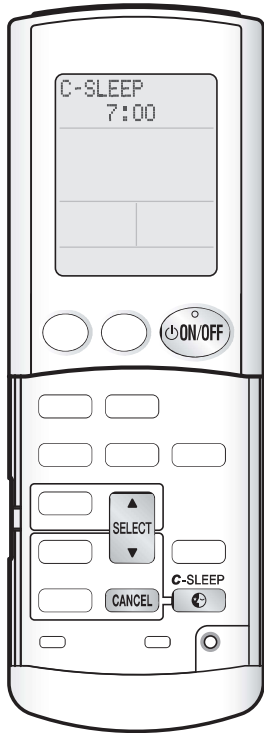

Controlling the room temperature supports comfort sleep and pleasant wake-up.

- Check that the clock is correct. If not, set the clock to the present time. ▶Page 9
- The present time display disappears when the COMFORT SLEEP operation is set.

1. Press during operation.

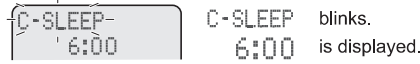



2. Press to set the time to wake up.

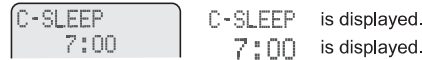

- Pressing the button changes the time in 10 minutes. Holding the button makes the time change faster.

3. Press .



- When settings are made while the unit is not running, press  to start the operation.

■ To cancel COMFORT SLEEP operation

Press .

ATTENTION

- Make the room temperature comfortable to some extent before sleep.
 <Recommended set temperature> **COOLING**79°F – 84°F (26°C – 29°C)
HEATING68°F – 77°F (20°C – 25°C)
- * Too low set temperature may cause you to get chilled while asleep.

NOTE

■ Notes on COMFORT SLEEP operation

- Can be used for COOLING, DRY COOLING and HEATING.
- Cannot be used with TIMER operation.

■ How to use COMFORT SLEEP operation effectively

- Starting COMFORT SLEEP operation lowers the set temperature by 3.6°F (2°C) in 3 hours and starts raising it by 1.8°F (1°C) 1 hour before the set time, offering V-curve temperature control. (See the right figure.)
- Set the airflow direction so that the air from the unit does not directly blow on the occupants of the room.

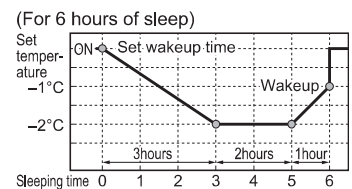

SET UP · CHILD PROOF LOCK

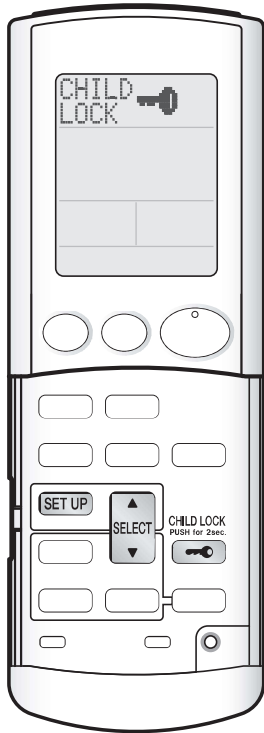

■ SET UP

Sets the unit operation and remote controller display according to your preference.

1. Press **SET UP**.

- The setup mode will be activated.

2. The item will change every time **SET UP** is pressed.

3. The settings will change every time **SELECT** is pressed respectively.

- Direct the remote controller toward the main unit to make settings.

is default.

Item	Setting	Description
CELSIUS/FAHRENHEIT change	<input type="checkbox"/> °F <input checked="" type="checkbox"/> °C	• Switches the temperature between Celsius and Fahrenheit.
MONITOR BRIGHTNESS	<input checked="" type="checkbox"/> HIGH <input type="checkbox"/> LOW <input type="checkbox"/> OFF	• Changes the brightness of the indoor unit display.
BEEP volume	<input checked="" type="checkbox"/> LOW <input type="checkbox"/> HIGH <input type="checkbox"/> OFF	• Sets the receiving tone volume.
CONTRAST setting	1 <input type="checkbox"/> <input checked="" type="checkbox"/> 6 <input type="checkbox"/> 16	• Sets the grayscale for the remote controller LCD. • Selectable from contrast 1 to 16.

Setting complete : The display on the remote control goes back to normal if no setting is made for 10 seconds.

■ CHILD PROOF LOCK

Restrict the remote controller operates to avoid misuse by children.

Press **CHILD LOCK** for about 2 seconds.

- “**CHILD LOCK**” is displayed.

■ To cancel CHILD PROOF LOCK

Press **CHILD LOCK** for about 2 seconds again.

INFORMATION DISPLAY

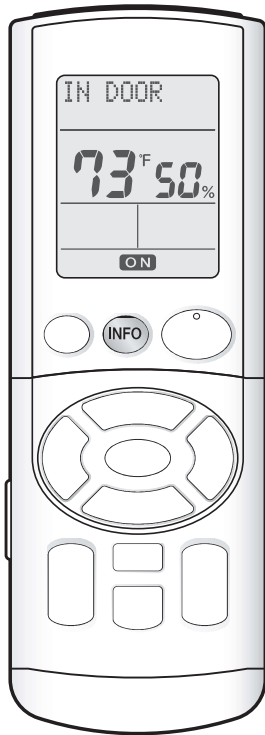

Displays the room temperature and humidity and outdoor temperature.

Press **INFO**.

- After pressing **INFO**, point the remote controller at the air conditioner unit for 2 seconds.

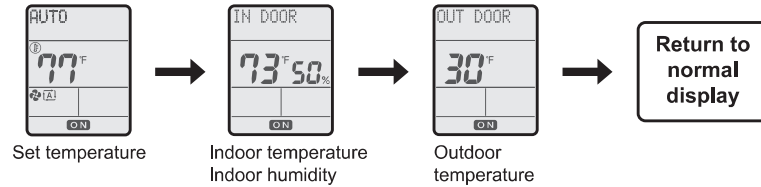

■ The display changes every time **INFO** is pressed.

NOTE

■ Notes on INFORMATION DISPLAY

- The signal from the air conditioner is not being received properly if "RCV_ERR" or "RETRY" is displayed when you press **INFO**. Repeat, aiming the remote controller at the air conditioner.
- During operation, the outdoor temperature may sometimes be displayed higher than it actually is in COOLING or "SARARA" DRYING operation or lower in HEATING operation (especially if frost has accumulated on the outdoor unit), due to the effects of the air blown from the outdoor unit or the temperature of the heat exchanger.
- The lowest indoor and outdoor temperature which can be displayed is 16°F (-9°C). This will be displayed even if the actual temperature is lower. The highest temperature is 99°F (37°C). This will be displayed even if the actual temperature is higher.
- The indoor and outdoor temperatures and the humidity which are displayed are those near the sensors attached to the main air conditioner unit.
- The displayed temperature and humidity should only be taken as approximations, as they may be affected if there are objects around the sensors or due to direct sunlight, depending on where the air conditioner is installed.

Care and Cleaning

Quick reference

⚠ CAUTION

- Before cleaning, be sure to stop the operation and turn the breaker off.
- Do not touch the aluminum fins of the indoor unit. If you touch those parts, this may cause an injury.

Titanium apatite photocatalytic air-purifying filter (black)

Soak

if "CLEAN STREAMER" displays.

- Replace once in about 3 years.

▶Page 26

Upper panel

Wipe off

if it gets dirty. ▶Page 22

Streamer unit

Soak

if "CLEAN STREAMER" displays.

- Replace once in about 3 years.

▶Page 26

Deodorizing filter for streamer (black)

Soak

if "CLEAN FILTER" display.

- Replace once in about 3 years.

▶Page 26

Air filter

Vacuum Rinse

if "CLEAN FILTER" displays.

▶Page 23

Front panel

Wipe off

if it gets dirty. ▶Page 21

To reset the filter cleaning indicator

While the unit is not operating, the filter cleaning indicator may be displayed on the remote controller depending the amount of time the unit had been operating. This sign indicates the cleaning timing for the air filter, Titanium apatite photocatalytic air-purifying filter, deodorizing filter for streamer or streamer unit.

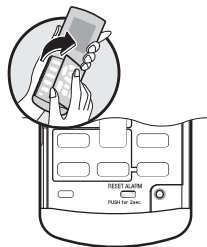

After cleaning, press **RESET ALARM** for about 2 seconds directing the remote controller toward the main unit with powered off.

- Indication disappears.

NOTE

- "CLEAN FILTER" sign will appear after about 340 hours of operation.
- "CLEAN STREAMER" sign will appear after about 1800 hours of operation.
- Operating the unit without cleaning with the "CLEAN STREAMER" sign displayed will lower the deodorizing capability.
- Periodical cleaning leads to energy saving.

CAUTION

- Only open the front panel after turning the unit off.
Opening the panel during operation may cause the panel to fall off.

Attaching and removing the front pane

1. Open the front panel.

- Placing a finger on the panel tab on either side of the front panel.

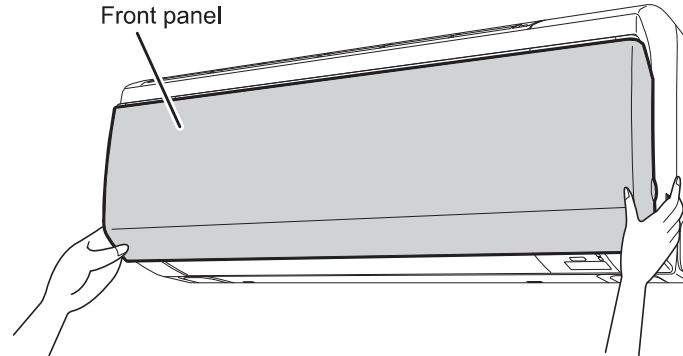

2. Remove the front panel.

- Spread out the shaft hole and remove the front panel shaft. (Both left and right sides.)

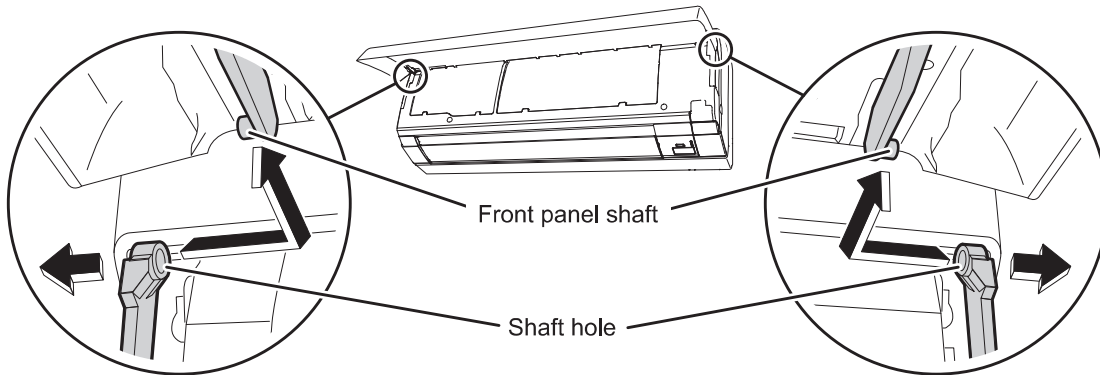

3. Attach the front panel.

- Place the revolving axes on either side of the front panel into the holes and slowly close.
(Press either side of the front panel.)

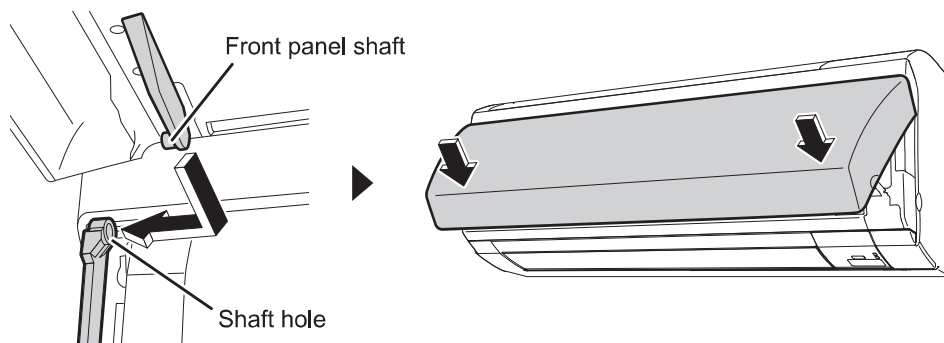

Care and Cleaning

Attaching and removing the upper panel

1. Remove the front panel and pull out the air filter. ▶Page 23

2. Remove the upper panel.

- 1) Hold the 2 tabs on either side of the upper panel and pull forward to remove.
- 2) Remove the tab in the center and lift.

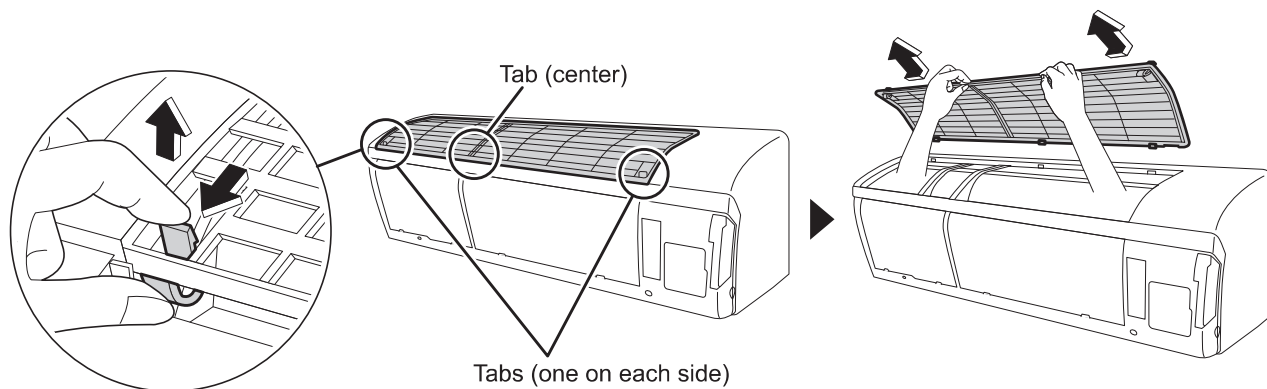

3. Attach the upper panel.

- Insert the 3 tabs on back of the upper panel and then push it down.
- Push the upper panel down until it clicks.

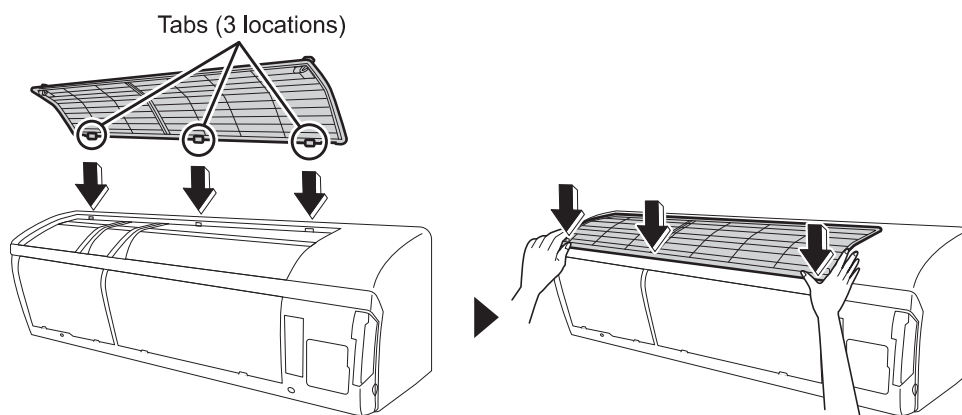

Cleaning for each case

- Wipe it with a soft cloth soaked in water. (Only neutral detergent may be used.)
- In case of washing the front panel with water, dry it with cloth, dry it up in the shade after washing.

CAUTION

- When removing or attaching the front panel, use a robust and stable stool and watch your steps carefully.
- When removing or attaching the front panel, support the front panel securely with hand to prevent it from falling.
- For cleaning, do not use hot water above 104°F (40°C), benzine, gasoline, thinner, nor other volatile oils, polishing compound, scrubbing brushes, nor other hand stuff.
- After cleaning, make sure that the front panel is securely fixed.
- Wipe the front panel with a soft cloth. Wiping with a hard cloth may scratch it.

Cleaning the air filter

(If  is displayed on the remote controller)

1. Open the front panel.

- Open the front panel by placing a finger on the panel tab on either side of the front panel and then secure it using the supporting plate on the right.

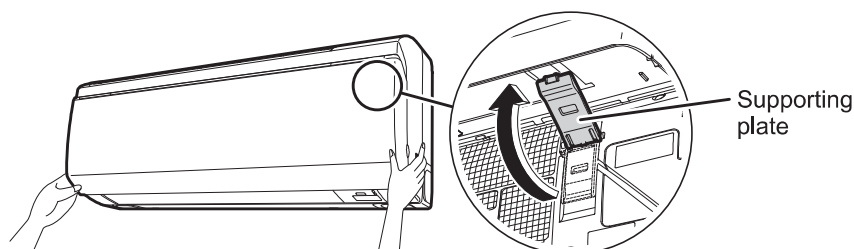

2. Pull out the air filters.

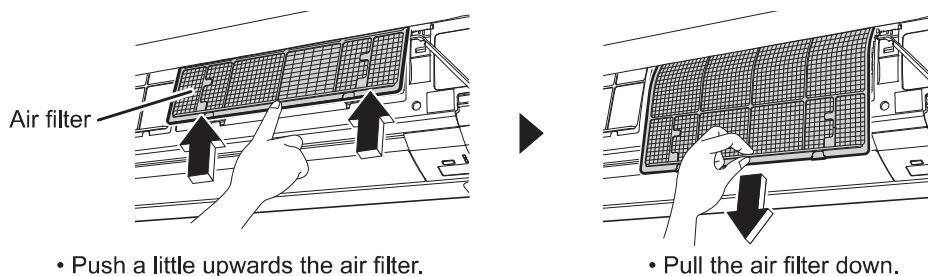

• Push a little upwards the air filter.

• Pull the air filter down.

3. Clean the air filter.

- Wash the air filters with water or clean them with vacuum cleaner.
- If the dust does not come off easily, wash them with neutral detergent thinned with lukewarm water, then dry them up in the shade.

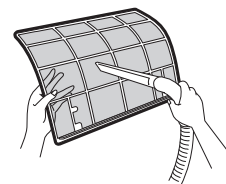

4. Set the air filter as it was and close the front panel.

- Insert the air filter with the "FRONT" marking to the front.
- Be sure to insert the two tabs below.
- Return the supporting plate to its previous position.
- Press either side of the front panel.

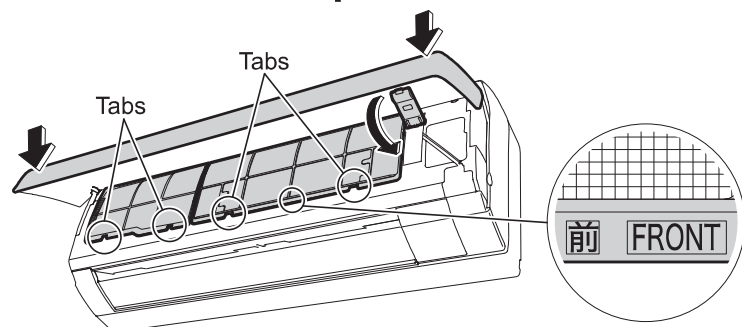

5. Reset the filter cleaning indicator. Page 20

NOTE

- Using without cleaning will lower the COOLING or HEATING capability, wasting electricity.

Care and Cleaning

Attaching and removing the deodorizing filter for streamer, Titanium apatite photocatalytic air-purifying filter, streamer unit

Titanium apatite photocatalytic air-purifying filter

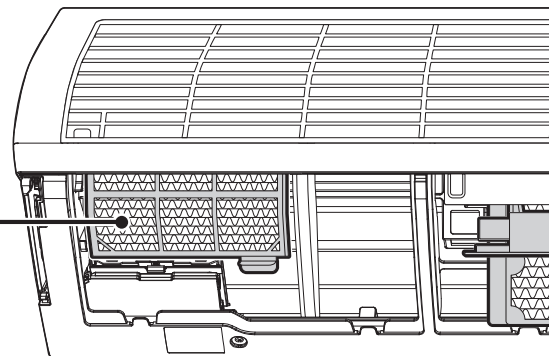

Removing

1. Open the front panel and pull out the air filter. ▶Page 23

2. Remove the deodorizing filter for streamer.

- Discharge the tab and pull out the knob in a downward direction.

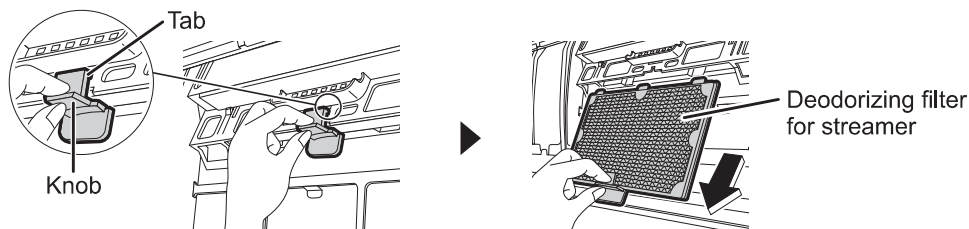

3. Pull out the streamer unit.

- Hold the center of the handle and pull out in a downward direction.

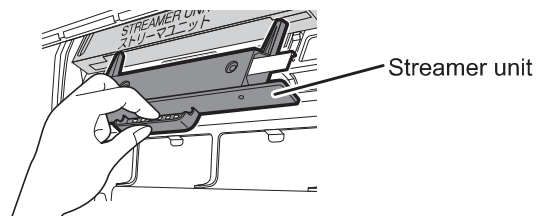

4. Remove the Titanium apatite photocatalytic air-purifying filter.

- Pull up the filter frame, discharge the tabs on both sides of the Titanium apatite photocatalytic air-purifying filter from the hooks, and pull down the filter in a downward direction.

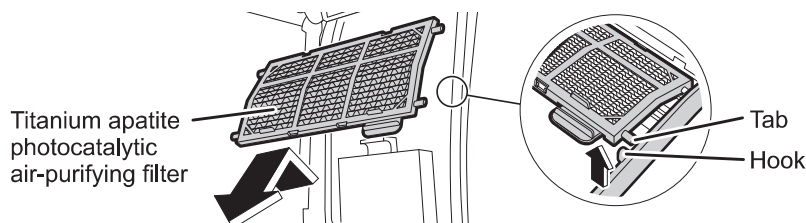

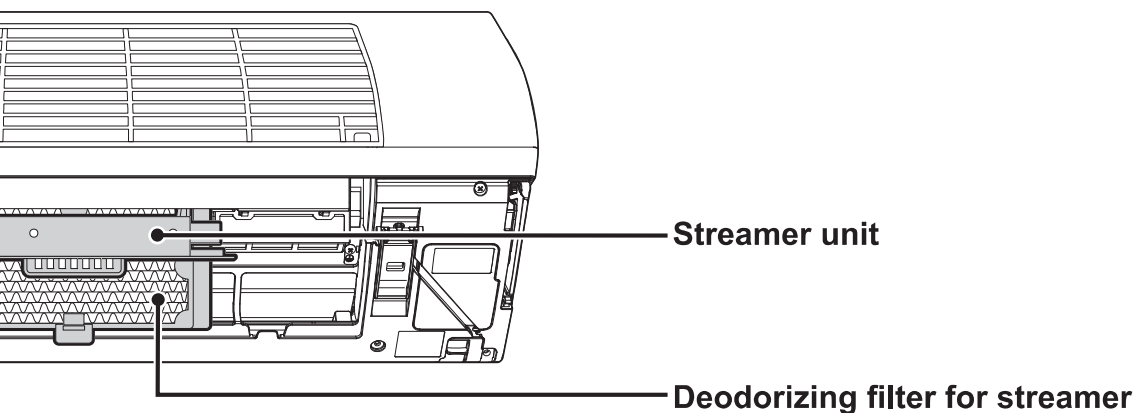

Attaching

1. Replace the streamer unit to its original position.

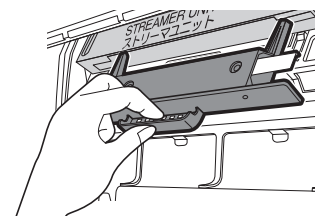

2. Attach the deodorizing filter for streamer.

- Insert the deodorizing filter for streamer until it clicks.

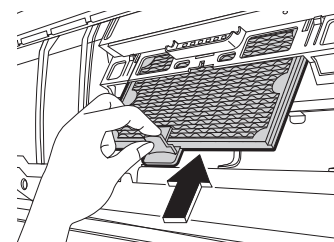

3. Attach the Titanium apatite photocatalytic air-purifying filter.

- Insert the 2 upper tabs on the Titanium apatite photocatalytic air-purifying filter into the guides on the main unit and then hook up the 2 lower tabs.

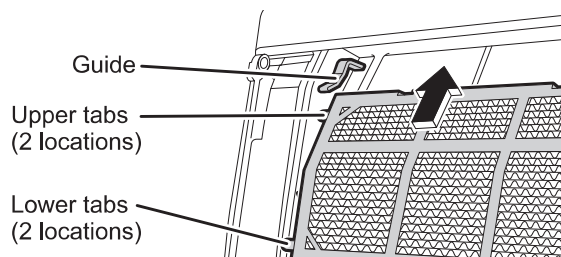

4. Replace the air filter to its original position and close the front panel. ▶Page 23

Care and Cleaning

Cleaning the deodorizing filter for streamer, Titanium apatite photocatalytic air-purifying filter and streamer unit

(If  is displayed on the remote controller)

■ Attaching and removing each part ▶Page 24, 25

Deodorizing filter for streamer/Titanium apatite photocatalytic air-purifying filter

Vacuum dusts, and soak in warm water or water for about 10 to 15 minutes if dirt is heavy.



Soak for about 10 to 15 minutes.

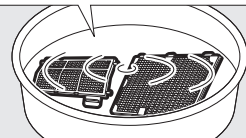

Warm water or water

- Do not use cleaning agents. This may lower deodorizing capability.
- Do not scrub the filter while cleaning.
- Do not take the filter out of the frame while soaking.
- After soaking, drain water away and dry well in a shade.
- Do not squeeze the filter to drain away water.

Streamer unit

1) Soak in warm water with mild liquid detergent for about 1 hour.

Soak for about 1 hour.

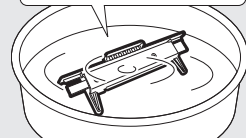

With detergent

- Observe the volume of mild liquid detergent specified in the instruction.
- Do not use powder or alkaline detergent.
- If very dirty, disassemble the streamer unit and clean with cotton swabs, etc.

(Disassembly instructions: ▶Page 27)

Disassembly

2) Rinse with running water and soak in warm water or water again.

Soak for about 30 minutes.

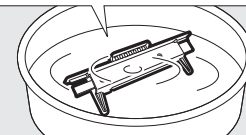

Warm water or water

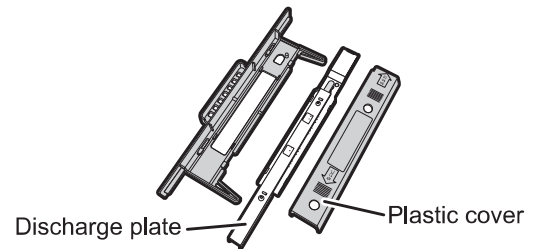

Discharge plate

Plastic cover

3) Rinse with running water.

Discharge plate

4) Drain water away and dry in a breezy shade.

About 1 day

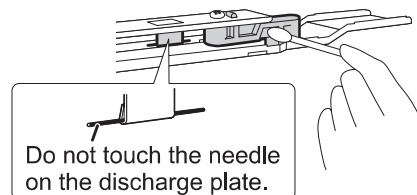
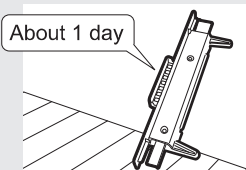

Do not touch the needle on the discharge plate.

Do not touch the needle on the discharge plate (2 locations). Bending the needle will affect the unit's ability to deodorize.

■ Resetting the filter cleaning indicator ▶Page 20

NOTE

- Using without cleaning lowers the deodorizing capability.

How to replace

■ Deodorizing filter for streamer

(Once in about 3 years)

- Remove from the filter frame and replace the filter with a new one.

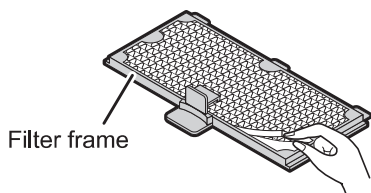

■ Titanium apatite photocatalytic air-purifying filter

(Once in about 3 years)

- Discharge the 4 tabs of the filter frame and replace the filter with a new one.

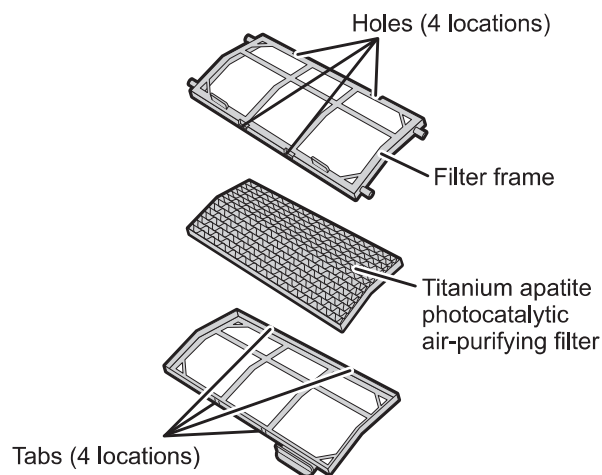

- The deodorizing filter for stream and the titanium apatite photocatalytic air-purifying filter do not have front and back sides.
- Dispose a used filter as burnable waste. (material: paper)

How to disassemble and assemble the streamer unit

- Before disposing the streamer unit, disassemble it.

How to disassemble

- Use gloves for safety.
- Apply one hand to the striped part and push the plastic part with another hand.
- Disassemble the streamer unit into the plastic cover and the discharge plate.
- Match up the securing parts of the various parts of the streamer unit and assemble as it was.

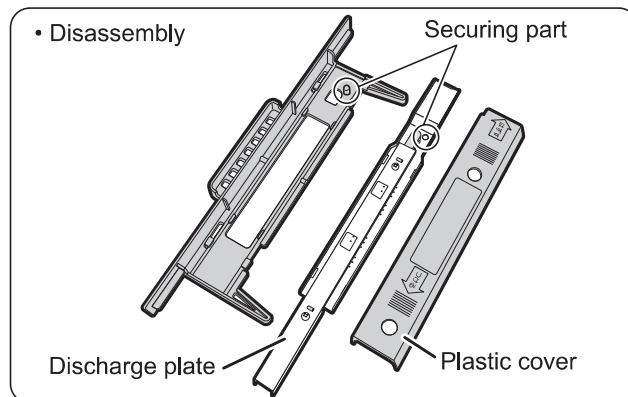
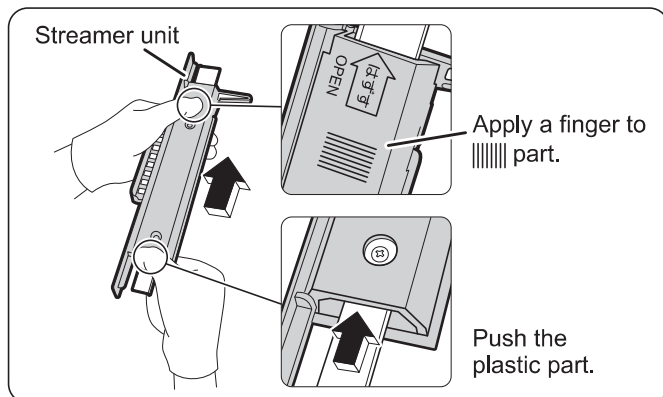

! CAUTION

- Be careful not to cut yourself when disassembling and assembling the streamer unit.

Cleaning the indoor unit and the remote controller

- Wipe with a soft dry cloth.
- For cleaning, do not use hot water above 104°F(40°C), benzene, gasoline, thinner, nor other volatile oils, polishing compound, scrubbing brushes, nor other hand stuff.

Care and Cleaning

NOTE

- The deodorizing filter for stream and the titanium apatite photocatalytic air-purifying filter should be cleaned regularly. We recommend replacing the filter in the following situations.

- If it is damaged during cleaning because it is made of paper.
- If it is very dirty after long use.

Item	Part No.
Air purifying filter set	KAF974B42S

- To order Titanium apatite photocatalytic air-purifying filter, deodorizing filter for streamer and streamer unit contact to the service shop there you bought the air conditioner.
- Using the dirty parts will:
 - Prevent proper air purification.
 - Prevent proper deodorizing.
 - Reduce COOLING and HEATING capacity.
 - Cause the unit to produce foul odors.

■ Check the units

- Check that the base, stand and other fittings of the outdoor unit are not decayed or corroded.
- Check that nothing blocks the air inlets and the outlets of the indoor unit and the outdoor unit.
- Check that the drain comes smoothly out of the drain hose during COOLING or DRY operation.
 - If no drain water is seen, water may be leaking from the indoor unit. Stop operation and consult the service shop if this is the case.
- Is the earth wire out or disconnected in the middle?
 - An incomplete ground wire may cause electrical shock. Contact the service shop.

■ Before a long idle period

1. Operate the “FAN only” for several hours on a fine day to dry out the inside.

- Press 
- Press  and start operation

2. After operation stops, turn off the breaker for the room air conditioner.

3. Clean the air filters and set them again.

4. Take out batteries from the remote controller.

■ We recommend periodical maintenance.

- In certain operating conditions, the inside of the air conditioner may get foul after several seasons of use, resulting in poor performance. It is recommended to have periodical maintenance by a specialist aside from regular cleaning by the user.
- For specialist maintenance, contact the service shop where you purchased the air conditioner.
- The maintenance cost must be born by the user.

Troubleshooting

These cases are not troubles.

The following cases are not air conditioner troubles but have some reasons. You may just continue using it.

Case	Explanation
Operation does not start soon. <ul style="list-style-type: none"> When ON/OFF button was pressed soon after operation was stopped. When the mode was reselected. 	<ul style="list-style-type: none"> This is to protect the air conditioner. You should wait for about 3 minutes.
Hot air does not flow out soon after the start of HEATING operation.	<ul style="list-style-type: none"> The air conditioner is warming up. You should wait for 1 to 4 minutes.
Makes a noise.	<ul style="list-style-type: none"> Clicking sound can be heard either when the unit is running or stopped <ul style="list-style-type: none"> This is either the sound of the valves regulating the refrigerant or the electrical parts working. Sound of running water <ul style="list-style-type: none"> Refrigerant is flowing through the air conditioner. Blowing sound <ul style="list-style-type: none"> The flow of refrigerant through the air conditioner is switching. Creaking sound <ul style="list-style-type: none"> The air conditioner itself is expanding or shrinking due to a change in the humidity. Clopping sound <ul style="list-style-type: none"> Can be heard coming from inside the air conditioner when the ventilator is on and the room is shut. Open a window or turn off the ventilator. Clicking sound can be heard either when the unit is running or stopped <ul style="list-style-type: none"> This is the sound of the electrical parts working when the front panel opens or closes. Blowing, cracky or burning sound <ul style="list-style-type: none"> This is the sound of streamer discharging.
Units stops during HEATING and the sound of running water can be heard.	<ul style="list-style-type: none"> The frost on the outdoor unit is being removed. You should wait for about 3 to 10 minutes.
The outdoor unit emits water or steam.	<ul style="list-style-type: none"> In HEATING operation <ul style="list-style-type: none"> The frost on the outdoor unit melts into water or steam when the air conditioner is in defrost operation. In COOLING operation <ul style="list-style-type: none"> Moisture in the air condenses into water on the cool surface of outdoor unit piping and drips.
Mist comes out of the indoor unit.	<ul style="list-style-type: none"> This happens when the air in the room is cooled into mist by the cold air flow during COOLING operation. This is because moisture on the heat exchanger evaporates when "SARARA" DRYING operation is run after COOLING or DRY COOLING operation.
The indoor unit gives out odor.	<ul style="list-style-type: none"> This happens when smells of the room, furniture, or cigarettes are absorbed into the unit and discharged with the air flow. (If this happens, we recommend you to have the indoor unit washed by a technician. Consult the service shop where you bought the air conditioner.)
Cold air blows at the start of "SARARA" DRYING operation.	<ul style="list-style-type: none"> This is because the air conditioner is not warmed up.
The outdoor fan rotates while the air conditioner is not in operation.	<ul style="list-style-type: none"> After operation is stopped: <ul style="list-style-type: none"> The outdoor fan continues rotating for another 60 seconds for system protection. While the air conditioner is not in operation: <ul style="list-style-type: none"> When the outdoor temperature is very high, the outdoor fan starts rotating for system protection.
The operation stopped suddenly. (Multi-monitor lamp is on.)	<ul style="list-style-type: none"> For system protection, the air conditioner may stop operating on a sudden large voltage fluctuation. It automatically resumes operation in about 3 minutes.
Unit stops suddenly (when in ON TIMER operation).	<ul style="list-style-type: none"> Reserving the on timer will cause the unit to start running up 1 hour before, in order to make sure the temperature reaches the temperature set on the remote controller by the set time. Using the remote controller during this time (other than the operation/stop button) will stop the unit. Restart the unit with the remote controller.
Unit operates even though the multi-monitor lamp is off.	<ul style="list-style-type: none"> The multi-monitor lamp will go off if "Monitor OFF" is set using the remote controller.

Troubleshooting

Check again.

Please check again before calling a repair person.

Case	Check
<p>The air conditioner does not operate. (Multi-monitor lamp is off.)</p>	<ul style="list-style-type: none"> • Hasn't a breaker turned off or a fuse blown? • Isn't it a power failure? • Are batteries set in the remote controller? • Is the timer setting correct?
<p>The air conditioner does not operate. (Multi-monitor lamp flashes.)</p>	<ul style="list-style-type: none"> • Turn off the breaker and then start the unit using the remote controller. • If the lamp still flashes, consult the service shop where you bought the air conditioner. Turn off the breaker.
<p>Operation stops suddenly. (Multi-monitor lamp flashes.)</p>	<ul style="list-style-type: none"> • Are the air filters clean? • Is there anything to block the air inlet or the outlet of the indoor and the outdoor units? <p>Clean the air filters or take all obstacles away and turn the breaker off. Then turn it on again and try operating the air conditioner with the remote controller. If the lamp still flashes, consult the service shop where you bought the air conditioner. Turn off the breaker.</p>
<p>Cooling (Heating) effect is poor.</p>	<ul style="list-style-type: none"> • Are the air filters clean? • Is there anything to block the air inlet or the outlet of the indoor and the outdoor units? • Is the temperature setting appropriate? • Are the windows and doors closed? • Are the airflow rate and the air direction set appropriately? • Is the ventilator fan spinning?
<p>An abnormal functioning happens during operation.</p>	<ul style="list-style-type: none"> • Do you put your hand in the main unit while it is operating? (Do you touch inside the unit?) • Putting your hand (or touching) inside the unit may cause malfunctions due to static discharge. Do not put your hand in the main unit. • The air conditioner may malfunction with lightning or radio waves. Turn the breaker off, turn it on again and try operating the air conditioner with the remote controller.
<p>Front panel does not open. (Multi-monitor lamp flashes.)</p>	<ul style="list-style-type: none"> • Is there something caught in the front panel? <p>Remove the object and attempt operation again using the remote controller. If the panel still does not open, contact your dealer if the operation lamp is still flashing.</p>
<p>The multi-monitor lamp flashes for a certain amount of time (about 2 minutes) at the start of or during FLASH STREAMER AIR PURIFYING operation.</p>	<ul style="list-style-type: none"> • Is the streamer unit installed securely? • Turn off the breaker, check to see if the streamer unit is installed securely, turn the power on, and then operate the unit again using the remote controller. • If the lamp still flashes, consult the service shop where you bought the air conditioner.

■ Call the service shop immediately.

WARNING

■ When an abnormality (such as a burning smell) occurs, stop operation and turn the breaker off.

- Continued operation in an abnormal condition may result in malfunctioning, electric shocks or fire.
- Consult the service shop where you purchased the air conditioner.

■ Do not attempt to repair or modify the air conditioner by yourself.

- Incorrect work may result in electric shocks or fire.
- Consult the service shop where you purchased the air conditioner.

■ If the air conditioner does not cool (or heat), leaking refrigerant is a possible cause, so please contact your dealer. Please talk to a service repairman about any repairs needed when adding refrigerant.

Refrigerant used for the air conditioner is safe. Refrigerant does not leak usually, but if it leaks into the room and comes in contact with any kind of flame, including those in fan heaters, gas stoves, gas heaters, etc., toxic gas may be generated.

If one of the following symptoms takes place, call the service shop immediately.

- The power cord is abnormally hot or damaged.
- An abnormal sound is heard during operation.
- An object or water got into the unit.
- The safety breaker, a fuse, or the ground leakage breaker cuts off the operation frequently.
- A switch or a button often fails to work properly.
- There is a burning smell.
- Water leaks from the indoor unit.

Turn the breaker off and call the service shop.



- Cool or warm air comes from the unit but the multi-monitor lamp blinks for a certain amount of time (about 2 minutes) at the start of or during operation.

This indicates the malfunction or initial failure of the humidifying unit or some sensors. The unit is operating in COOLING/HEATING operation as a temporary operation. Contact your dealer.



■ After a power failure

- The air conditioner automatically resumes operation in about 3 minutes. Wait for it to restart.
- COMFORT SLEEP operation will be canceled. Re-set.

■ Lightning

- If lightning may strike the neighbouring area, stop operation and turn the breaker off for system protection.

■ Precautions for Interior Cleaning of Air Conditioner

Commercially available detergent for air conditioners can degrade the sterile effect of the air conditioner and exert a bad influence on the interior resin and heat exchanger of the air conditioner. Moreover, in the worst case, it may result in serious problems such as water leakage.

Consult your service shop for the cleaning of the heat exchanger.

Troubleshooting

■ FAULT DIAGNOSIS BY REMOTE CONTROLLER

In the ARC447A3, the temperature display sections on the main unit indicate corresponding codes.

1. Hold the timer cancel button down for 5 seconds, with the remote controller set toward the indoor unit.

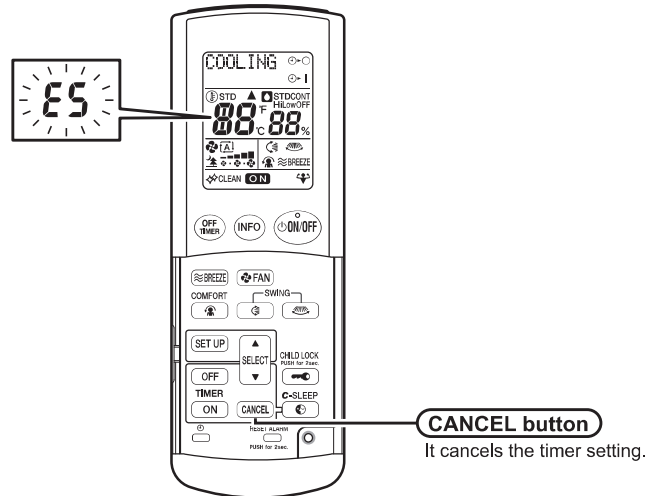

2. The temperature display on the remote controller changes to the error code display and a long beep notifies this indication change.

	CODE	MEANING
SYSTEM	00	NORMAL
	UA	INDOOR-OUTDOOR UNIT COMBINATION FAULT
	U0	REFRIGERANT SHORTAGE
	U2	DROP VOLTAGE OR MAIN CIRCUIT OVERVOLTAGE
	U4	FAILURE OF TRANSMISSION (BETWEEN INDOOR UNIT AND OUTDOOR UNIT)
	U7	CIRCUIT BOARD TRANSMISSION FAULT
INDOOR UNIT	AH	STREAMER FAULT
	A1	INDOOR PCB DEFECTIVENESS
	A5	HIGH PRESSURE CONTROL OR FREEZE-UP PROTECTOR
	A6	FAN MOTOR FAULT
	C4	FAULTY HEAT EXCHANGER TEMPERATURE SENSOR
	C7	FRONT PANEL OPEN/CLOSE FAULT
OUTDOOR UNIT	C9	FAULTY SUCTION AIR TEMPERATURE SENSOR
	EA	COOLING-HEATING SWITCHING FAULT
	E1	CIRCUIT BOARD FAULT
	E5	OL STARTED
	E6	FAULTY COMPRESSOR START UP
	E7	DC FAN MOTOR FAULT
	E8	OVERCURRENT INPUT
	FA	EJECTION PRESSURE FAULT
	F3	HIGH TEMPERATURE DISCHARGE PIPE CONTROL
	F6	HIGH PRESSURE CONTROL (IN COOLING)
	H0	SENSOR FAULT
	H6	OPERATION HALT DUE TO FAULTY POSITION DETECTION SENSOR
	H8	CT ABNORMALITY
	H9	FAULTY SUCTION AIR TEMPERATURE SENSOR
	J3	FAULTY DISCHARGE PIPE TEMPERATURE SENSOR
	J6	FAULTY HEAT EXCHANGER TEMPERATURE SENSOR
	L3	ELECTRICAL PARTS HEAT FAULT
	L4	HIGH TEMPERATURE AT INVERTER CIRCUIT HEATSINK
L5	OUTPUT OVERCURRENT	
P4	FAULTY INVERTER CIRCUIT HEATSINK TEMPERATURE SENSOR	

NOTE

- To cancel indication of error code, hold the timer cancel button down for 5 seconds.
The code display also cancels itself if the button is not pressed for 1 minute.

DAIKIN AC (AMERICAS), INC.

1645 Wallace Drive, Suite 110
Carrollton, TX75006

info@daikinac.com
www.daikinac.com

DAIKIN INDUSTRIES, LTD.

Head office:

Umeda Center Bldg., 2-4-12, Nakazaki-Nishi,
Kita-ku, Osaka, 530-8323 Japan

Tokyo office:

JR Shinagawa East Bldg., 2-18-1, Konan,
Minato-ku, Tokyo, 108-0075 Japan



Two-dimensional bar code is a code for manufacturing.

3P226009-1A M07B240A (1211) HT